



OPERATOR'S MANUAL

Original

En (English)



ENGLISH

FOREWORD

This manual explains the proper operation and maintenance of Toyota industrial vehicles as well as daily lubrication and periodic inspection procedures.

Please read this manual thoroughly even though you may already be familiar with other Toyota industrial vehicles because it contains information which is exclusive to this series of vehicles. This manual is based on a standard vehicle. If you have any questions about other types, please contact your Toyota industrial vehicle dealer (Toyota dealer).

In addition to this manual, please be sure to read the separate publication entitled "Operator's Manual for Safety Operation." Toyota reserves the right to make any changes or modifications of specifications in this manual without giving previous notice and without incurring any obligation.

CONTENTS

Foreword 2 (En-1)
 Contents 2 (En-1)
 Before Initial Operation 2 (En-1)
 Caution Plate 5 (En-4)
 Main Components 6 (En-5)
 Driving Controls and Instruments Panel 6 (En-5)
 General Screen 7 (En-6)
 Display 9 (En-8)
 Screen Functions 10 (En-9)
 Optional Features 13 (En-12)
 Switches and Levers 19 (En-18)
 Body Components 24 (En-23)
 Battery 27 (En-26)
 Pre-operation Check 30 (En-29)
 Weekly Maintenance 32 (En-31)
 Self Servicing 33 (En-32)
 Periodic Maintenance 34 (En-33)
 Periodic Replacement Table 34 (En-33)
 Periodic Maintenance Table 34 (En-33)
 Service Data 37 (En-36)
 Battery Case & Minimum Weight Required 38 (En-37)
 Wheels & Tires (3W) 39 (En-38)
 Wheels & Tires (4W) 39 (En-38)
 Lubrication Chart (3W) 40 (En-39)
 Lubrication Chart (4W) 41 (En-40)
 Vehicle Dimensions 42 (En-41)
 Frame Serial Number 43 (En-42)
 How to Read the Name Plate 43 (En-42)
 Mast Specifications and Rated Capacities 44 (En-43)

BEFORE INITIAL OPERATION

- **Please read this manual thoroughly.** This will give you a complete understanding of Toyota industrial vehicles and enable you to operate them correctly and safely. Proper handling of new vehicles promotes performance and extends life. Drive with special caution while becoming familiar with a new vehicle. In addition to the standard operating procedures, pay attention to the following safety items.
- **Please acquire a thorough knowledge of the Toyota industrial vehicle.** Read the operator's manual thoroughly prior to operating the vehicle. Get to know its operation and components. Learn about the safety devices and accessory equipment and their limits and precautions. Be sure to read the caution plate attached to the vehicle.
- **Please familiarize yourself with safe driving techniques and safety management.** Understand and maintain work area traffic rules. Ask the work area supervisor about any special working precautions.
- **Wear neat clothing for operation.** Improper clothing for vehicle operation may interfere with smooth operation and cause an accident. Always wear proper clothing for easy operation.
- **Avoid electric power lines.** Know the locations of inside and outside power lines and maintain sufficient distance.
- **Be sure to perform pre-operation checks and periodic maintenance.** This will prevent sudden malfunctions, improve work efficiency, reduce costs, and help ensure safe working conditions.
- **Be sure to avoid forward tilt when the loaded forks are raised.** In the worst case, this will cause overturning due to poor stability resulting from forward shifting of the center of gravity.
- **If you hear any abnormal noises or sense anything unusual, inspect and repair immediately.**
- **Never attempt traveling with a load on the forks lifted beyond the specified height.** Traveling with a load on the forks lifted beyond the specified height may cause overturning due to upward shifting of the center of gravity. Keep the forks at 15-20 cm (5.9 -7.9 in.) above the ground when traveling.
- **Avoid overloading or uneven loading.** Overloading or uneven loading is dangerous. If the center of gravity is closest to the front side even though the load is below the maximum, limit the loading weight according to the name plate.
- **Avoid reckless operation.**
- **Use only the recommended lubricants.** Low-grade lubricants will shorten service life.
- **Do not overdischarge.** Always check the condition of the battery.
- **Avoid open flames during charging.** Combustible gas is produced during charging. Charge away from open flames in a well-ventilated place.
- **Cold Storage Models.** A cold storage model option is not available. Do not perform operations in a cold storage.
- **Do not make any alterations to the electrical system.** Any attempt to do so may affect the operation of the precision devices built into the battery-operated forklift, causing a malfunction or accident. If any alterations become necessary, contact a Toyota dealer.
- **When washing the forklift, be careful not to splash the motor or electrical parts directly with water.** If the motor or electrical parts are directly splashed with water, the forklift may malfunction or break down. If it becomes unavoidable to wash the battery-operated forklift, carefully cover electrical parts with a vinyl sheet or the like to protect them from getting wet.
- **Return to neutral mechanism.** If the key switch or the seat switch is turned ON with the direction lever set to the forward or reverse position or the accelerator pedal depressed, the vehicle does not travel unless the direction lever and accelerator pedal are returned to the neutral positions.
- For vehicles that are equipped with non-marked or color tires, be sure to install a static strap.

Cautions for thunder

- If thunder can be heard in the distance, stop charging the battery and disconnect the charging plug.
- If thunder can be heard close by, do not touch the power supply plug or cord because you may receive an electric shock if lightning strikes close by.
- Setup of a lightning rod or a lightning arrester in the electric circuit is strongly recommended in areas where thunder is frequently heard.



Safety requirement

Truck equipped with a load bearing clamp (e.g. paper clamp) shall feature control(s) with a secondary action to prevent unintentional release of the load.

When any "load bearing clamp" is used on a lift truck, the control (hydraulic hand lever for example) must be configured to confirm to the ISO3691.

Caution for using the model with SAS (System of Active Stability)

⚠ Caution

Whenever you drive an SAS model, please check the caution plate to discover which functional features the vehicle has. Do not operate the vehicle before making sure that each of the features is operating properly.



3 wheels model



4 wheels model

- While driving the vehicle, be alert for warning indicators and/or alarm buzzers. Should an error code be indicated by a warning indicator, park the vehicle in a safe location and have it inspected at a Toyota dealer.
- The SAS, which is electronically controlled, must be initialized after maintenance is performed. Do not unnecessarily remove or modify any SAS features. Whenever an inspection is necessary, contact a Toyota dealer.
- When washing the vehicle, carefully prevent water from splashing directly over the electronic components (controller, sensors and switches) employed in the SAS.

Description of features available in SAS models

Active control rear stabilizer

(4 wheels models only)

When the vehicle makes a turn on the spot, a centrifugal force is generated in the lateral direction of the vehicle. In such an event, this feature will operate so that the rear wheels will be locked to prevent swinging and the vehicle will be supported on four wheels. Thus, vehicular stability will be enhanced in both right and left directions.

⚠ Caution

With the vehicle locked to prevent swinging, stability increases. Nevertheless, it is not the case that the vehicle will never tip over. Always operate the vehicle correctly.

Automatic forks leveling control

- With the vehicle not loaded, press the tilt lever knob button to turn it on and tilt the mast forward. This will cause the forks to stop automatically in a horizontal position (with the mast in the vertical position).
- After pressing the tilt lever knob button and stopping the forks in a horizontal position, you may want to tilt the mast further. To do this, return the tilt lever to the neutral position once. Then, press the tilt lever knob button to turn it off and operate the tilt lever.

When the tilt lever knob button is turned on and the tilt lever is operated from the backward to forward position, the mast will perform as follows:

	Not loaded	Loaded
High lift height	Stop with leveling forks (mast vertical)	No front tilt
Low lift height	Stop with leveling forks (mast vertical)	Stop with mast vertical (or up to 1° to rear side) depending on the load

⚠ Caution

- If you press the tilt lever knob button while the mast tilted forward with a heavy load at high lift, the mast will stop operating. Do not operate the automatic forks leveling control during material handling operation because the vehicle may tip over.
- In case of a vehicle with an attachment, do not allow the forks to be automatically positioned horizontally with a heavy load at a high lift while the motor is running at a high speed. This will lead to a hazardous situation.
- Mounting heavy attachments onto some specialty models may disable automatic forks leveling control. Confirm with a Toyota dealer in advance.

Note:

- The mast will not tilt forward if the tilt lever knob button is turned on while there is a heavy load at high lift (2 m or more).
- When the mast is tilting forward from a vertical position, it will not tilt further forward even if the tilt lever knob button is turned on.
- When the mast is tilting backward, the forks will not stop in a horizontal position even if the tilt lever knob button is turned on.

Active mast forward tilt angle control

According to lifting height and load, the angle at which the mast can be tilted forward is automatically controlled within a range of angles illustrated below.

	Light load (no load)	Intermediate load	Heavy load
High lift height	No restriction for front tilt angle	Front tilt angle is restricted from 1° to 5°	Front tilt angle is restricted to 1°
Low lift height	No restriction for front tilt angle		

⚠ Caution

- If a load is lifted while the forks are tilted forward at a low lift, the vehicle may tip over when the forks stop at a position having a tilt angle beyond the specified angle range. Never lift the load, therefore, while the mast is tilted.
- With a heavy load at a high lift, never adjust the load position by controlling the mast forward tilt angle, as the vehicle may tip over.
- Even with a load positioned within the allowable angle range, never tilt the mast beyond its vertical position, or the vehicle may tip over, losing its stability forward and backward. Never tilt the mast forward when a load is lifted.
- Mounting heavy attachments onto some specialty models may disable active mast forward tilt control. Confirm with a Toyota dealer in advance.
- After mounting or replacing any attachment have it inspected at a Toyota dealer.
- If you use two or more removable attachments alternately, the heaviest one should be used to carry out matching (SAS setting). Ask a Toyota dealer for help in advance.

Note:

With the forks raised to the maximum height, high pressure (relief pressure) may remain in the lift cylinder. This high pressure causes the vehicle to judge that it has a heavy load even if unloaded. As a result, forward tilting of the mast is disabled. In this case, lower the forks slightly from the top (to release the pressure), and the mast can be tilted forward.



Active mast backward tilt angle control

When the tilt lever is operated backward from the forward tilt position with the automatic fork leveling control switch depressed, the fork automatically levels itself (mast vertical) and then the mast tilting stops.

Note that only the load conditions changes its operation as shown below:

	Not loaded	Loaded
High lift height	Stop with leveling forks (mast vertical)	Stop with mast vertical (or up to 1° to rear side) depending on the load
Low lift height		

The value of load weight judged as “loaded” is same as the intermediate load on Active mast front tilt angle control.

Active mast forward/backward tilt speed control

- At a high lift, the mast forward or backward tilt speed is controlled (slowed down) regardless of load weight. Even if the lifting height changes from high to low while the mast tilts forward or backward, the control speed will remain in effect.
- At a low lift, the mast can be tilted backward at full speed regardless of load weight. **If the tilt lever knob button is turned on and the mast tilted backward at a low lift, the backward tilt speed of the mast is controlled (slowed down) as long as the tilt lever knob button is turned on.**
- If the forks are raised from a low lift to a high lift while the mast is tilting backward, the control speed will remain in effect as long as the tilt lever knob button is turned on. The mast tilts backward at the maximum speed when the tilt lever knob button is turned off.
- The forward/backward tilt speed control is controlled by the rpm of the pump motor. Never lift at a high lift or perform simultaneous operation of attachment and tilt.

Key-lift interlock

With the key switch at OFF, the forks will not lower even if the lift lever is so operated.

Active steering synchronizer

If the steering wheel knob is not aligned with the tires, the offset will be corrected automatically while the steering wheel is turned. Thus, the knob is kept at a constant position relative to the tires.

If the SAS feature should fail:

An SAS model is controlled with a controller, sensors and various actuators. If any of them is found not to be operating normally, the following may occur:

- Steering wheel knob offset may not be corrected.
- Such features as automatic forks leveling control, active mast forward tilt angle control and active mast forward/backward tilt speed control may be disabled.
- Swing lock may not be unlocked.

If any of the phenomena referred to above should take place,

- Diagnosis operation indicator will come on.
- An error code will be displayed.
- A buzzer will sound.

Thus, the operator will be informed. In such an event, move the vehicle to a safe location and have it repaired at a Toyota dealer.

OPS SYSTEM

The OPS (Operator Presence Sensing) system prevents traveling and load handling operations when the operator is not seated in the operator's seat. If the operator leaves the seat while the vehicle is in operation, the OPS indicator will be displayed on the screen and a buzzer will sound for 0.5 seconds to inform the operator that the system is going to be activated. If the operator remains away from the seat for 2 seconds, the system will be activated and stop the current operation. However, if the operator returns to the seat within 2 seconds, the system will not be activated and operation can be continued normally.

If an error occurs within the OPS system, an error code will be displayed on the screen to inform the operator of the error. This indicates that the OPS system may be faulty. Have the vehicle inspected by your Toyota dealer.

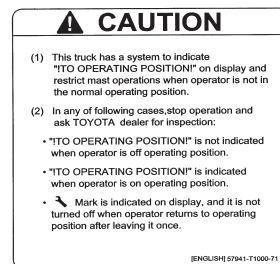

This vehicle is equipped with the OPS system. Confirm the functions of the OPS system before operation.

Travel OPS Functions

When the controller detects the seat switch turned off for two seconds, the drive motors stop after acting as the regenerative brake.

Travel OPS is released by returning the direction lever and accelerator pedal to the neutral position and turning on the seat switch. On the D2 pedal vehicle or the Double Accel pedal vehicle, releasing the accelerator pedal makes the direction signal neutral, then it cancels the travel OPS.

Here, the degree of the regenerative brake changes depending on the detected height and weight of the load as follows:

	Light load (no load)	Loaded
High lift height	Regenerative brake same as that of the accelerator pedal off	The regenerative brake decreases as the weight of load increases
Low lift height	Regenerative brake same as that of the accelerator pedal off	

Load Handling OPS Functions

Mini-lever or joystick vehicle

When the controller detects that the seat switch is turned off for 2 seconds, controlling the electric proportional valves stops the movements of lift, tilt, and attachments. At the same time, the lift lock valve and tilt control valve stop lifting down and tilting forward. The movement of lift up and attachment are also stopped because the supply of the hydraulic oil is intercepted by controlling the unload valve.

Hydraulic function OPS is released by returning all the levers to the neutral positions and turning on the seat switch.

OPS Operation Alarm Functions

When the controller detects that the seat switch is turned off, the onboard buzzer in the multi-function display informs OPS operation to the operator by sound (pipi) for 1 second. And the multi-function display turns on the OPS indicator in advance at that time.

If the operator notices it and sits down before 2 seconds pass, the OPS will not activate.

In order to inform that the OPS is operating, the OPS indicator keeps being turned on while the seat switch is turned off.

Load Handling Functions

When the seat switch is turned on without returning the hydraulic control lever to the neutral position, sounding (pipipipi) informs the operator that the hydraulic function OPS is not released.

Return to neutral warning

When traveling motion is stopped by the OPS system, sitting in the seat and depressing the accelerator pedal without returning the direction lever to its neutral position will sound a buzzer to indicate that the motion stop has not been released. Sitting in the seat with the accelerator pedal depressed will also activate this alarm.

OPS Controller Abnormality Warning

If an error occurs within the OPS system, an error code is displayed on the screen to inform the operator of the error. This indicates that the OPS system may be faulty. Park the vehicle in a safe location and have it inspected by your Toyota dealer. Also, in any of the following cases, stop operation and have the vehicle inspected by your Toyota dealer.

- The OPS indicator is not displayed on the screen when the operator leaves the seat.
- The OPS indicator does not turn off when the operator sits in the seat.

Recycling/Discarding

In accordance with EU Directive 2006/66/EC, this symbol indicates “separate collection” for all batteries and accumulators.



Your trucks use a lead accumulator and, in case of some battery powered truck, a lithium battery.

Materials contained in batteries (include accumulators) are hazardous to the environment and humans, so batteries should be returned to the manufacturers for recycling.



Discarding the battery

When the working life of the battery in the truck is at an end (exchange to a new battery) or if the entire truck is to be scrapped, special regard to the environment risks shall be taken when disposing/recycling batteries. Consult your Toyota dealer about exchange or discarding the batteries.

CAUTION PLATE

A caution plate is attached to the vehicle. Thoroughly familiarize yourself with its contents before operating the vehicle. (The sample shows the English version.)

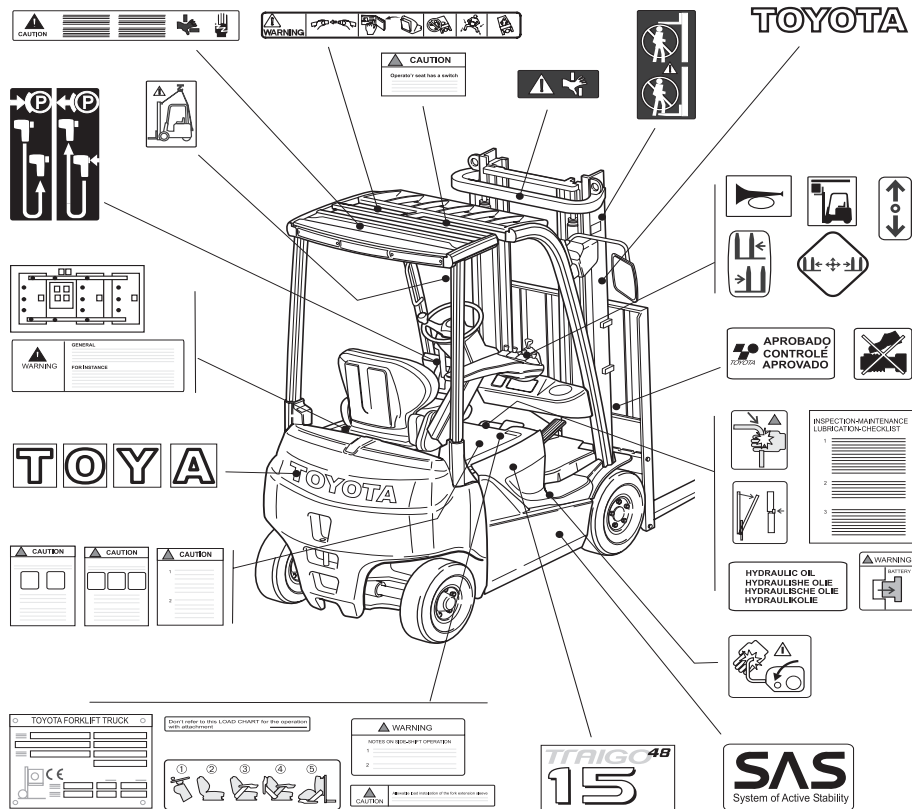

About this mark
Warnings! Please read this Operator's Manual carefully before use.



MAIN COMPONENTS

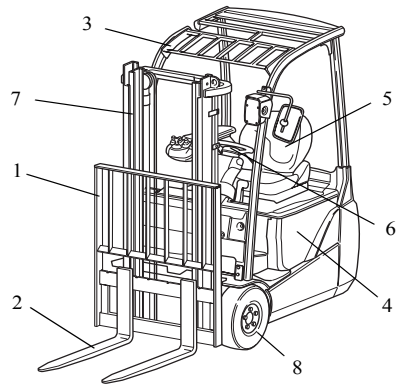

1. Backrest
2. Forks
3. Head guard
4. Battery
5. Operator's seat
6. Steering wheel
7. Mast
8. Front wheel

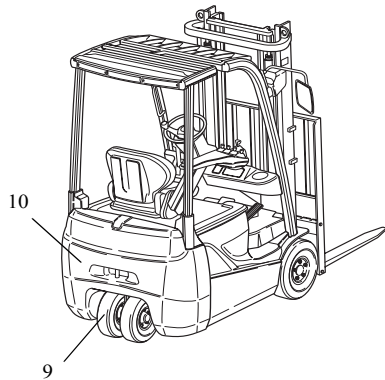

9. Rear wheel
10. Counterweight

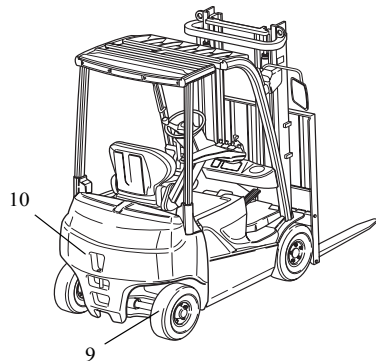

DRIVING CONTROLS AND INSTRUMENTS PANEL

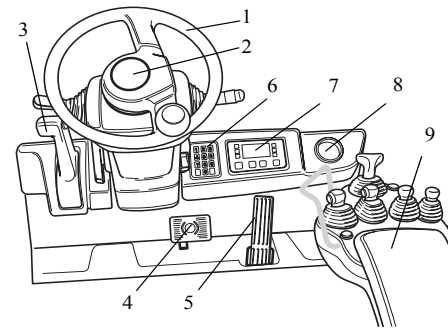

1. Steering wheel
2. Horn button
3. Parking brake lever
4. Brake pedal
5. Accelerator pedal
6. PIN code entry system (OPT)
7. Multi-function display
8. Cup holder
9. Armrest

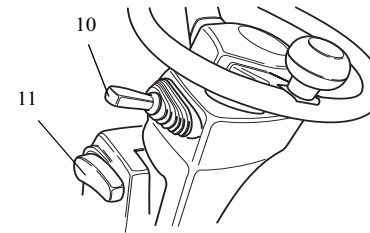

10. Lefthand direction lever (OPT)
11. Steering column tilt adjust lever

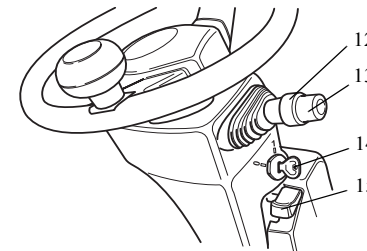

12. Lamp switch (OPT)
13. Turn signal switch (OPT)
14. Key switch
15. Steering column lock lever

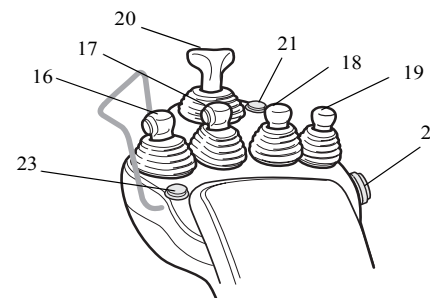

16. Lift lever
17. Tilt lever
18. Attachment lever
19. Attachment lever (OPT)
20. Direction lever
21. Height limiter (OPT)
22. Emergency stop button (OPT)
23. Horn button (OPT)



GENERAL SCREEN

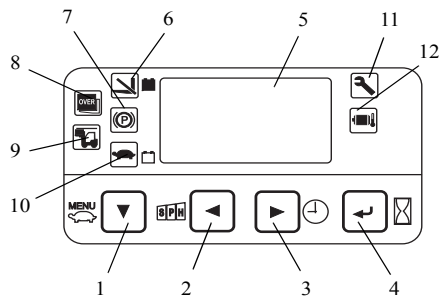

1. Travel 2nd speed control set switch
2. Power selection switch
3. Time or date selection switch
4. Meter mode selection switch
5. Multiple screen display area
6. OPS indicator
7. Parking brake indicator
8. Over load indicator
9. Height limiter indicator
10. Travel 2nd speed setting indicator
11. Diagnostic mode indicator
12. Overheat warning indicator

Travel 2nd speed setting indicator

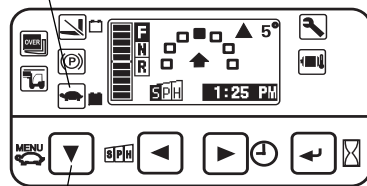

switch (1)

power select indicator

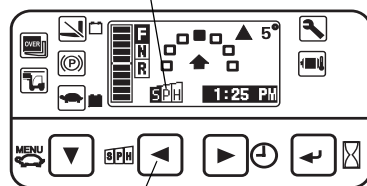

switch (2)

Travel 2nd speed control set switch

Press switch (1) to switch the activation the travel 2nd speed setting function. The travel 2nd speed setting indicator informs of its activation.

Power selection switch

Press switch (2) on the general screen to change the traveling/material handling power select mode.

Enclosing all of "SPH" indicates that the original mode is selected.

date / time display

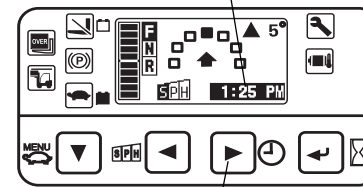

switch (3)

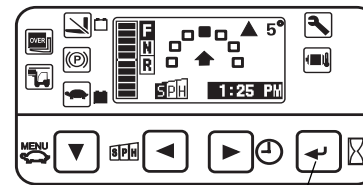

switch (4)

Time or date selection switch

Press switch (3) on the general screen to switch the date and time display.

Meter mode selection switch

Press switch (4) to switch the hour meter display.



OPS indicator

This indicator lights when the operator leaves the seat with the parking brake released, and the buzzer sounds for one second. This is not available before "hour meter start".



Parking brake indicator

This indicator lights while the parking brake is in operation. Parking brake indicator keeps lighting and buzzer sounds when the operator attempts to travel without releasing the parking brake. Before traveling, check that the parking brake indicator has gone out.

⚠ Caution

If the indicator does not go out when the parking brake is released, stop operating the vehicle and have it inspected at a Toyota dealer.



Over load indicator (OPT)

Over load indicator lights and the buzzer sounds to warn the operator if the detected weight goes over the preset value when the operator is displaying the load meter by the load display switch.



Height limiter indicator (OPT)

Height limiter indicator lights when height limiter is in effect. For details, see "Height limiter".



Traver 2nd speed setting indicator

This indicator comes on or goes off whenever the operator presses the travel 2nd speed control set switch. This indicator is lit when the low speed is effect, limiting the vehicle speed at a preset value. The speed control value can be set using the low speed setting screen.



Diagnostic mode indicator

If the key switch is turned to ON while any abnormality is occurring or if any abnormality occurs while the vehicle is in use, this indicator blinks and the warning buzzer sounds. At this time, a diagnosis error code is displayed in the multi-screen display area. The error code varies with each error location and error level.

⚠ Caution

If the diagnosis mode indicator is displayed, have the vehicle inspected at a Toyota dealer.



Overheat warning indicator

Overheat indicator lights and buzzer sounds for five seconds, to warn the operator in the case of temperature rise of traveling motor, pump motor, main circuit or controller.

In error stage, the sound is kept until the error is recovered. Although error code is not displayed on the multi-function display, it is recorded by the system. Overheating part is displayed on the screen:

C/R: Main controller

DCR: Traveling motor driver or main circuit

PCR: Pump motor driver or main circuit

DM: Traveling motor

PM: Pump motor

When overheated, the performance of vehicle is limited.

After the warning indicator is displayed, leave the vehicle with the key switch on for a while (20 to 30 minutes).

⚠ Warning

If the warning indicator does not go out after 20 to 30 minutes, have it inspected immediately at a Toyota dealer.

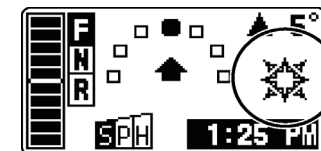
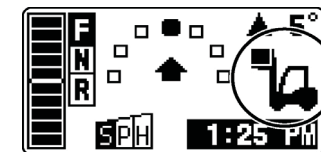
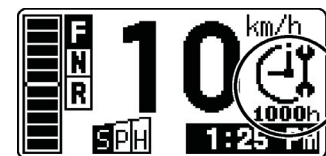
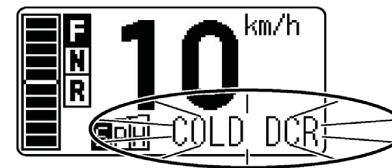
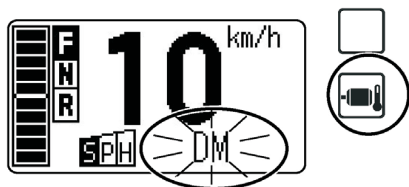

Other alarms and indicators

Return to neutral alarm

Buzzer sounds to warn the operator to be seated, to release the accelerator pedal, and to return the direction lever to the neutral position before traveling. It also sounds to warn the operator to return the material-handling levers to the neutral position before material handling.

Low temperature warning

Warning message is displayed on the multi-function display and buzzer sounds when the traveling motor driver or pump motor driver temperature is too low.

Display information:

COLD DCR: Traveling motor driver

COLD PCR: pump motor driver

When the low temperature warning is detected, the performance of vehicle is limited.

Maintenance indicator

When the time set in the maintenance hour meter comes, it will notify with the indicator display and a buzzer sounds.

Travel and load handling control indicator (Deluxe model with auto speed control only)

This indicator is displayed when the auto speed control is active. See Auto speed control.

Over speed alarm

When the set speed is exceeded, the speed indicator blinks and the buzzer sounds to inform the operator of the over speed.

Unlike low speed setting, even if the set speed is exceeded, any speed limitation is not applied.

The over speed value can be set using the over speed alarm setting screen.

Shock indicator (OPT)

When the shock goes over the preset value, the shock indicator blinks and the buzzer sounds, until the administrator resets it.

See "Shock indicator display".



DISPLAY

The multi-function display helps operators to identify various information easily by changing screens depending on the vehicle conditions

Multi-function display deluxe (OPT)

The Multi-function display Deluxe model has the following functions added to the multi-function display.

- Mast tilt indicator
- Load meter
- Over load alarm

Initial screen

Initial screen is displayed for two seconds after key-switch is turned on.

- 1) Date display
- 2) Travel speed limiter active
- 3) Overspeed alarm active
- 4) Auto speed control active
- 5) Maximum height limiter active
- 6) Shock sensor present
- 7) Active mast front tilt control disabled

Some features are explained further in this chapter.

Work screen

Different features are displayed on screen, depending if the truck is traveling or stopped.

- 1) Battery capacity indicator
- 2) Power select indicator
- 3) Time indicator
- 4) Direction indicator
- 5) Wheel indicator
- 6) Speedometer
- 7) Mast tilt indicator

Some features are explained further in this chapter.

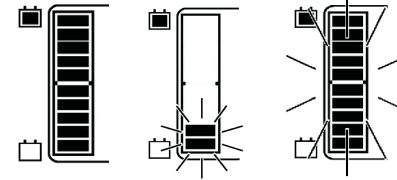
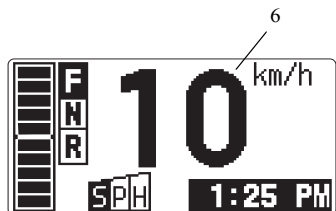
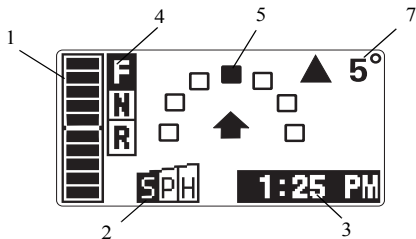
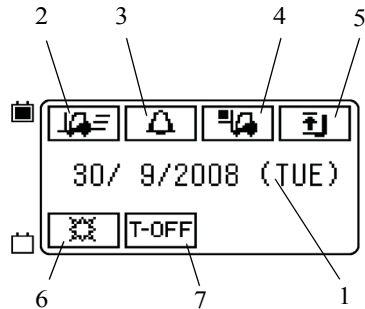

Battery capacity indicator

Battery capacity indicator indicates amount of charge in the battery in 10 stages.

When the battery capacity reaches the set warning level of remaining charge (default: second level):

- (1) The battery capacity blinks.
- (2) After the key switch is turned to ON, a warning buzzer sounds for 5 seconds.

If the battery is further discharged, all segments in the battery level indicator blink and a buzzer sound to warn the operator.

⚠ Caution

- If the battery capacity indicator blinks, stop operation early and charge the battery.
- To change the set level, consult with a Toyota dealer.

Power select indicator

Three modes of traveling/material handling performance are displayed.

- H..... H mode
The most active mode.
- P..... P mode
The high efficiency mode.
- S..... S mode
The longest operation mode.

Note:

H mode is the setting that focused on working efficiency, and maximum performance is demonstrated with traveling and material handling. Operating hour is about 65% of S mode. P mode is the setting that focused on the balance between working efficiency and operating hour. Operating hour is about 80% of S mode. S mode is the setting that focused on operating hour. Operating hour is same as S mode of previous model

Time indicator

It shows time: hour and minute (in 12/24 hours).

Speedometer

Speedometer indicates the vehicle speed digitally in 1 km/h or 1 mph. When the truck is stopped, this part of the display changes in the wheel indicator mode.





Direction indicator

The pre-set traveling direction (by direction switch) is indicated.

F Forward

Upward arrow is also shown if vehicle is stationary.

N Neutral

No arrow is shown

R Reverse

Downward arrow is also shown if vehicle is stationary.

Wheel indicator

The indicator indicates traveling direction of the vehicle by " ■ " "

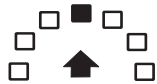

▲ 5° in forward-tilted state

0° in horizontal state

▼ 5° in backward-tilted state

Mast tilt indicator

(Multi-function display deluxe only)

The tilt angle of the mast is displayed in unit of 1 degrees.

Note:

When the truck inclines to the front with a heavy load, the position where 0 degrees are displayed also inclines to the front.

On the other hand, auto-leveling control compensates the horizontal position to the back depending on the detected load.

Therefore, 0 degrees may not be displayed at the stopped position by auto-leveling control with a heavy load.

Diagnostic code display

When diagnosis is activated, the spanner indicator comes on and blinks and a buzzer sounds to warn the operator that some abnormality has occurred on the vehicle.

Also, up to six diagnosis error codes are displayed on the screen.

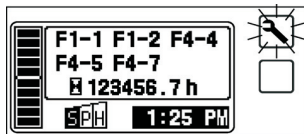

SCREEN FUNCTIONS

Power select

Every time the switch (2) is pushed in the general screen, the power select mode will shift to the right in sequence: S, P, H. When the original mode is selected, S, P, and H are shown with inverted colors.

Note:

If the administrator sets the menu lock ON, the power select cannot be changed.

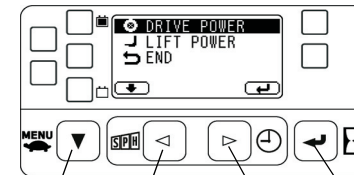

switch(1) switch(2) switch(3) switch(4)

Power control setting function

Press the switch (2) on the general screen for 2 seconds or more, the power control menu screen will be displayed.

Select an item with switch (1), and press switch (4) to display each setting screen.

Note:

- If the administrator sets the menu lock option ON, the power control setting menu screen cannot be displayed.
- This screen is not displayed in the PIN Code Entry System model.



Travel power control

Select the "DRIVE POWER" on the power control menu screen to display the drive power control screen.

Switch (2): Select the lower level.

Switch (3): Select the higher level.

Switch (4): Returning to Power control setting menu screen.

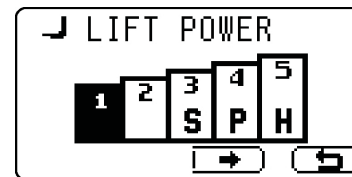

Material handling power control

Select the "LIFT POWER" on the power control menu screen to display the material handling power control screen.

Switch (2): Select the lower level.

Switch (3): Select the higher level.

Switch (4): Returning to Power control setting menu screen.

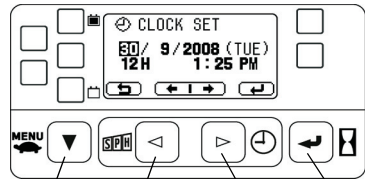

switch(1) switch(2) switch(3) switch(4)

Date and time display

Press switch (3) in the general screen, the date and time are displayed alternately.

Operation procedure

The year, month, day, time and 12/24-hour display can be set. Press switch (3) on the general screen for more than two seconds, and Clock set screen is displayed.

Functions of switches on the clock set screen:

Switch (1): exit (not set)

Switch (2): decrease the selected (blinking) value.

Switch (3): Increase the selected (blinking) value.

Switch (4): Enter the selected (blinking) value and proceed to the next item.

Pressing switch (4) while "MINUTES" is selected can complete setting and the screen returns to the general screen.

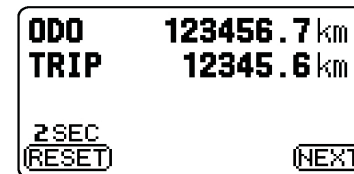
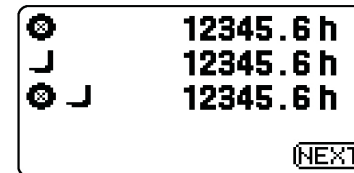

Multi meter display screen

Press switch (4) on the general screen, the display changes over in sequence of Key-ON hour meter, Lap time meter -> Traveling hour meter, Material handling hour meter -> Odometer, trip meter -> Maintenance hour meter -> general screen.

(1) Key switch on hour meter (KEY ON)
It counts the time when the key switch is turned on.
(When logged on for models with PIN code entry system.)

(2) Lap time meter (LAP)
It counts the time when the key switch is turned on.
(When logged on for models with PIN code entry system.)

Pressing switch (1) for more than two seconds can reset the meter.

(3) Drive motor service hour meter
It counts the time when the drive motors are activating on the power running mode or regenerative brake mode. (Not when the drive motors are freewheeling).

(4) Pump motor service hour meter
It counts the time when the pump motor is activating on the power running mode for the material handling operations. (Not when the motor is activating only for the power steering).

(5) Drive / pump motors service hour meter
It counts the time when the drive or pump motor are activating on the power running mode or regenerative brake mode. (Not either when the drive motors are freewheeling, or when the motor is activating only for the power steering).

(6) Odometer (ODO)
It counts the traveling distance of the vehicle.

(7) Trip meter (TRIP)
It counts the travel distance, and it can be reset. Pressing switch (1) for more than two seconds can reset the meter.

(8) Planned maintenance hour meter
The preset service interval time and the current elapsed time are displayed.

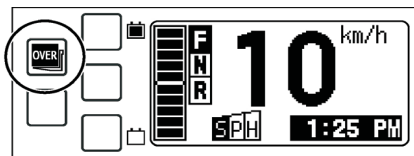
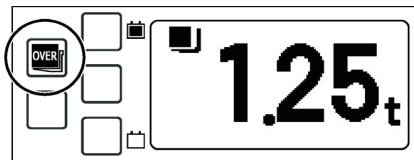
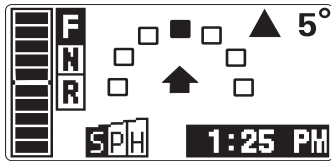
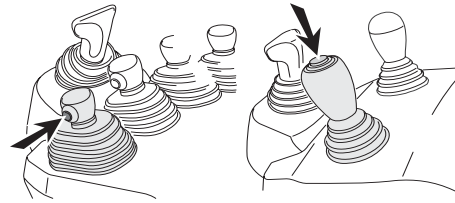

Load meter and over set load alarm

(Multi-function Display Deluxe Only)

Load Meter

Pressing the load display switch on the lift lever switches the general screen to the load meter screen, displaying the load weight in unit of 0.01 t.

Weights less than 100 kg are displayed as 0.00 t.

(Keeping pressing the switch continues to display the screen, but load meter screen doesn't appear while vehicle speed is detected.)

Conditions for measuring

The mast should be vertical and the forks height should be at height of approximately 500 mm for measuring.

Note:

- This function is not available for business dealings and certifications.
- It detects the lift cylinder pressure to facilitate measurements, so it should not be used to judge whether the overload value is near the allowable value.
- At the highest end, residual pressure is generated when the relief stops, and an overly large value is displayed.

Load meter screen at high-lift height

The accuracy drops because of the influence of the mast deflection and friction at the high lift position, so the screen changes in order to tell the operator to measure at the lower height.

Of course this screen is displayed on the models with V mast at the high lift position

Over set load alarm

An administrator can set the value to activate the "Over Set Load Alarm".

If the detected weight goes over the preset value when the operator is displaying the load meter by the load display switch, the lights of over load indicator and the buzzer sound inform the operator.

If a customer wishes the alarm to activate always, the technician can change it into such operation specification in masked function.

However in such operation specification, a lighter weight than the set value wrongly activates the alarm frequently because of fluctuations of load while driving, or because of increased load while lifting.

Note:

This function should not be used to judge the allowable load.

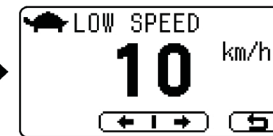
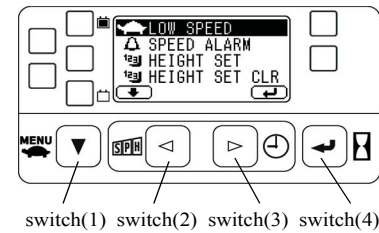

Setting screen

Press switch (1) on the general screen for more than 2 seconds will display the setting menu screen.

Select an item with switch (1), and press switch (4) to display each setting screen.

Note:

If the administrator sets the menu lock ON, the setting menu screen cannot be displayed.

Low speed setting screen

The limit speed of the Low-speed setting function can be changed.

Switch (2): Setting traveling speed down.

Switch (3): Setting traveling speed up.

Switch (4): Returning to setting menu screen.

It is adjustable from 2 to 50 km/h with a step of 1 km/h.

If the operator set the speed to more than 50km/h, the low speed function is disabled.

In that case "OFF" is displayed.

This screen is not displayed in the PIN Code Entry System model.

Over speed alarm setting screen

The speed to activate the over speed alarm function can be changed.

Switch (2): Setting traveling speed down.

Switch (3): Setting traveling speed up.

Switch (4): Returning to setting menu screen.

It is adjustable from 5 to 50 km/h with a step of 1 km/h.

If the operator sets the speed to more than 50km/h, the low speed function is disabled. In that case "OFF" is displayed.

This screen is not displayed in the PIN Code Entry System model.

Automatic height control setting screen

(Height Selector model only)

For details, see "Automatic height control".

Height limiter setting screen

(Height Selector model only)

For details, see "Height limiter".



OPTIONAL FEATURES

PIN code entry system (OPT)

With this feature, the key switch is replaced with a ten-key pad for PIN data entry.

Only operators who have registered PINs (Personal Identification Number) can activate the vehicle with this feature. This can contribute to avoidance of irregular uses by uncertified persons.

PINs range from 4 to 8 figures.

The system has one non-erasable "INITIAL PIN" for emergency, set by administrators.

This system also can register ten different vehicle settings called "PROFILE", and each PIN can be assigned one setting out of the ten settings.

Administrators can use this feature to limit various vehicle performances for safety management, or to fit the vehicle settings to each operator's favorites.

Caution

PIN code entry is not an anti-theft security system.

Login operation

The operator has to enter the PIN, and then press the login switch within 10 seconds, to activate the vehicle.

When each numerical key is pressed, the green LED lights and the buzzer sounds briefly.

The system checks the entered PIN to the registered PINs after pressing the login switch.

If the entered PIN is certificated, the buzzer sounds shortly, the green LED lights on and the vehicle activates.

The profile assigned by the PIN is loaded and the vehicle operates under the settings.

When the entered PIN is not certificated, the buzzer sounds longer and the system returns to the logoff state.

Pushing the logoff switch before completing entering a PIN reset the entered numbers and return the system to the logoff state.

Logoff operation

The operator can turn off the vehicle by pushing the logoff switch when the vehicle activates.

At that time, the system turns off the green LED, lights the red LED for one second, and the buzzer sounds briefly.

Leaving the vehicle without performing operations for a period of time (Auto power off setting) also turns it off automatically.

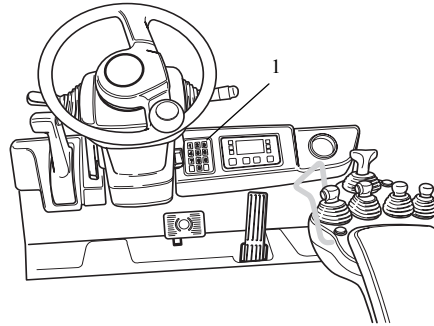

(1) PIN key pad

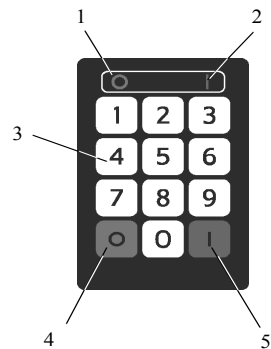

- (1) Red LED
- (2) Green LED
- (3) Numerical switches
- (4) LOGOFF switch
- (5) LOGIN switch

Protection from password attacks

The system has a protection function from the password attacks.

This function processes the following operations depending on counts to enter wrong PINs continuously.

1 - 4 : This function sounds the buzzer and lights the red LED for 1 second, and also prohibits from entering new PIN during this period.

5 - 10 : This function sounds the buzzer and lights the red LED for 5 seconds, and also prohibits from entering new PIN during this period.

11 - 20 : This function sounds the buzzer and lights the red LED for 1 minute, and also prohibits from entering new PIN during this period.

After the counts have reached to 20, the system transfers itself to the lock-mode.

The green and red LEDs blink simultaneously and the buzzer sounds for 5 seconds if an operator enters any PIN on this mode.

Only administrators can reset the lock mode.

Before the system has transferred itself to the lock-mode, it resets the counts to enter wrong PINs when a correct PIN for operators is entered.

The counts to enter wrong PINs don't increase by pushing the logoff switch before completing entering a PIN.



Height Selector (OPT)

This option consists of three functions that automatically stop the forks at the appropriate height as follows.

Maximum height limiter

The administrator can set a maximum height limit value. Subsequently, forks can never be raised over the height set by the operator.

Height limiter

The operator can set a maximum height value. Therefore, forks can't be raised over the height set.

The operator can enable/disable this feature by the height limiter switch (see "Switches and Levers").

Automatic height control

The operator can set up to three height favorite positions.

By pressing the automatic height control switch (see "Switches and Levers") the operator can enable one of the favorite height positions; therefore, forks can't be raised over that limit.

Note:

- This option is available only for FSW mast.
- In all functions with this option, the fork height settings should be more than the height value shown in the table.
- The actual forks height is varied by the weight of loads or by the mast angle.
- The backward tilt angle of the mast is restricted to five degrees if this option is installed.

Maximum fork height (mm)	Height value (mm)
4300	1715
4500	1785
4700	1885
5000	1985
5500	2185
6000	2335
6500	2535
7000	2735
7500	2935

Automatic height control value table



(1) "Maximum height limiter active" icon on Initial screen

Maximum height limiter

When the lift lever is operated upward and the forks reach the maximum height limiter position, the forks automatically stop there and buzzer sounds for a second.

If the lift lever is operated upward at the height where forks have already exceeded the maximum height limiter position, the forks never rise and the buzzer also sounds for a second.

Only the administrator can use the setting menu for "Maximum Height Limiter".

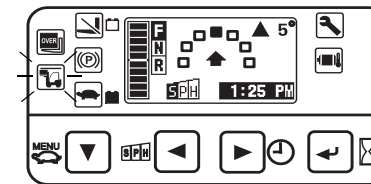
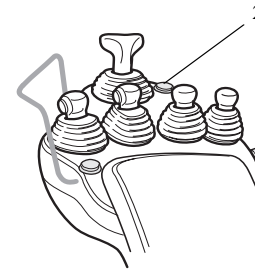

General screen

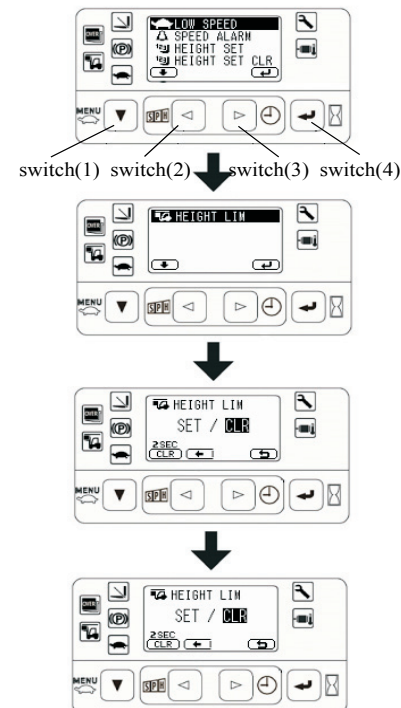

Height limiter

This feature activates only when the height limiter position is memorized and the height limiter switch (2) is pushed down.

When the lift lever is operated upward and the forks reach the memorized height limiter position, the forks automatically stop there and buzzer sounds for a second.

If the lift lever is operated upward at the height where forks have already exceeded the memorized height limiter position, the forks never rise up and the buzzer also sounds for a second.

Here, the operator can lift the forks up over memorized height limiter position by releasing the height limiter switch.

When the height limiter position is memorized and the height limiter switch is pushed down, the height limit indicator lights, to inform the operator that this feature is active.

Setting function

Operators can use the setting menu for "Height Limiter" on the operator's menu screen. See "Multi-function display".

The setting screen for "Height Limiter" is displayed by selecting the menu "HEIGHT LIM" by using the switch (1) and switch (4) on the operator's menu screen.

Operators can overwrite the memory of the height limiter at the current height by continuing to press switch (1) "SET" for two seconds under the condition that "SET" is selected by using switch (2) and switch (3).

Operators can also clear it by continuing to press switch (1) "CLR" for two seconds under the condition that "CLR" is selected by using switch (2) and switch (3).

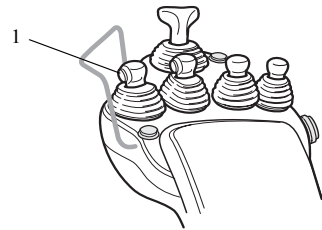

Automatic height control

Target selection before lift-up operation

The operator can memorize up to three favorite height positions (A, B and C) at the higher area than the height where the inner mast begins to rise.

Target height memory can be selected by click operation of the load display switch (1) while the lift lever is at neutral.

The click operation is defined as the brief push operation of the load display switch (1) within one second.

The long push operation over one second will be ignored. The controller takes it as the operation to display the load meter on models with the multi-function display deluxe (OPT).

Counts of clicks and the selected target memory are related as follows.

- 0 : This feature will not be activated.
- 1 : The lowest target is selected.
- 2 : The middle target is selected.
- 3 : The highest target is selected.

When the highest target has been selected, one extra click returns to the original situation of the count zero.

When the operator is selecting the target, the assistant screen is displayed as follows.

The order of the height memories is always displayed on the screen in low order.

Note:

- The first click always select the lowest target even if the forks height has already been over the lowest target position. This is to keep the constant relation between the number of clicks and the memory to be selected.
- No assistant screen is displayed when no position has been memorized.

Restriction on joystick models

On joystick models, favorite height can't be selected during tilting operations. Doing so activates the auto-leveling function.

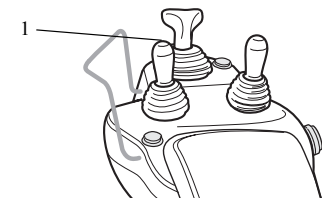

General screen



Lowest target screen



Middle target screen



Highest target screen

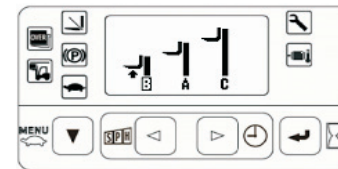

Example: Height of memories B<A<C

Cancel of the target and activation

Displaying the general screen by clicks can cancel the target before lift-up operation.

The target and the assistant screen are canceled if neither click nor lift-up operation is done over 10 seconds.

Operating the lift lever downward, or returning it to the neutral position while this feature is activating also cancels them.

Operation to stop the selected target

Operating the lift lever upward within 10 seconds with the target height selected and keeping the lever upward will stop forks automatically at the selected target.

At that time, the number of the short buzzer sounds informs the operator of the selected target height as follows while the lift lever is operated upward.

The lowest target: the single brief buzzer sound repeats with frequency of 1 second (pi..pi..pi..).

The middle target: two brief buzzer sounds repeat with frequency of 1 second (pipi..pipi..pipi..)

The highest target: three brief buzzer sounds repeat with frequency of 1 second (pipipi.. pipipi.. pipipi..)

Note:

- Returning the lift lever to the neutral position of course stops the lifting up immediately while this feature is activating.
- When a limitation function of the material handling or the OPS function activates, all the function of the Height Selector (including the screen) are canceled. The movement of the mast is halted.
- When selecting a favorite height position lower than the current height, this feature prevent forks from moving upward. In this case, the buzzer sounds for a second, and the screen informs the operator of the invalid operation.



Target change while lifting up

Only before the forks have stopped at the target, extra clicks can change the target to the next level up to the highest target memory.

But after they have once stopped at a target, one extra click cannot change the target to the next and the forks cannot be lifted until the lift lever has returned to neutral.

Note:

In such a case that the lift lever has already operated, the target can be changed only up to the highest memory in all the memories.

Neither cancel of the target nor change of the target to the lower level can be done by any clicks on the highest screen.

Setting function

Operators can use the setting menu for “Automatic Height Control” on the operator’s menu screen (“HEIGHT SET” menu).

Operator must lift the forks up to the height that they want to memorize. At this time, the setting screen displays the height relation between three memories and the current height. So operators can select the memory to overwrite out of A, B or C by using switch (2) and switch (3).

Continuing to press switch (1) “SET” for two seconds can overwrites the current height on the selected memory. If the memory has been overwritten, “OK” screen is displayed and the setting screen refreshed about the height relation is displayed by pressing the switch (4).

Note:

The height position cannot be memorized near the heights memorized in the other two memories. (On design it is within 100mm, but it may increase on various conditions).

In addition in the operator’s menu, all three memories can be cleared simultaneously.

The screen to clear all the memories is displayed by selecting the menu “HEIGHT SET CLR” by using the switch (1) and switch (4) on the operator’s menu screen.

Continuing to press switch (1) “CLR” for two seconds can clear all the memories on the screen.

Note:

The height position memories of the height limiter and maximum height limiter cannot be cleared by this procedure.

Interference avoidance with the load meter

If the multi-function display deluxe is taken as an option, the load display switch plays two roles for load meter switch and the height selector switch.

So the controller judges the period of pushing the button and controls the load meter and Automatic Height Control as follows.

(1) Long operation of the load display switch before lift-up
Before the lift lever is operated upward, the long push (over 1 second) can display the load meter.
The favorite height memory is kept at the selected position for 10 second from the moment when the switch is turned off.

(2) Long operation of the load display switch while the automatic height control is activating
After the Automatic Height Control has activated, all the long push (over 1 second) is ignored and the load meter is not displayed.
Of course the target memory is kept at the selected position.

Interference avoidance with the height limiter function

If the “maximum height limiter” or the “height limiter” is set, there is a case that the memorized positions of the Automatic Height Control are higher than the limited height by them.

The higher memory positions are ignored and cannot be selected. In addition, they are not displayed on the screen.

Note:

The ignored height memories become available again after the height limiter is disabled.

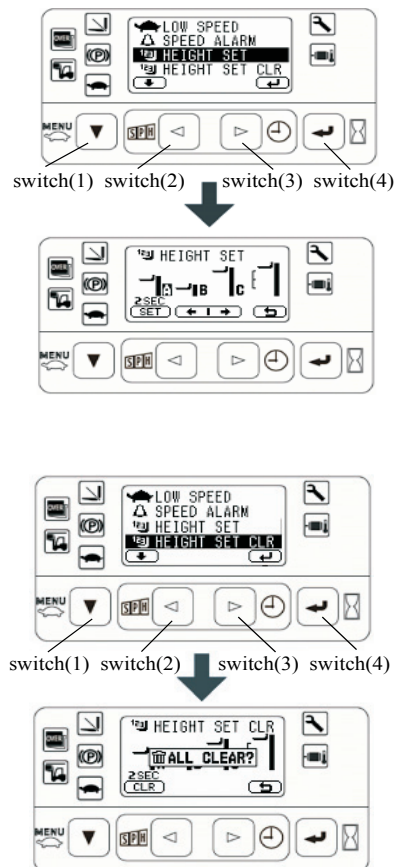

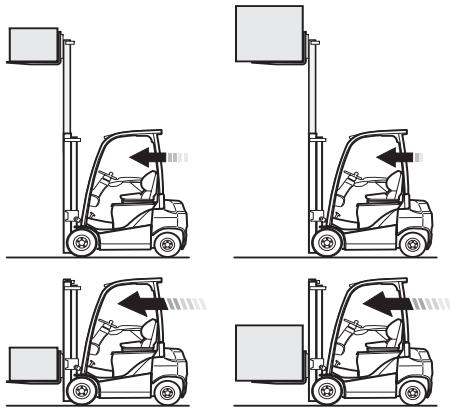

Auto speed control (OPT)

This function automatically limits the maximum speed, the acceleration and the deceleration by detecting the forks height (Low/High) and the loaded weight, reducing the possibility of falling of loads.

⚠ Caution

- Do not blindly rely on Auto Speed Control
- Maximum speed and the acceleration (deceleration) are suppressed corresponding to the weight of loads at high position. But it doesn't necessarily mean that it will not turn over. So safe driving is always necessary.
- When loads are lifted to high position, never step on the accelerator pedal suddenly, or never shift the vehicle from the neutral to driving condition with keeping the accelerator pedal stepped on.
- The fluctuations of the vehicle speed and acceleration can be caused temporarily even under the controlled condition, by changes of road conditions.

Specifications of control

Lift-height and load-sensing vehicle speed control

This feature improves the stability while driving with heavy loads at the high lift position, by limiting the maximum speed, depending on the load at the high lift position.

Height position and the weight of loads are detected by the height switch and the load sensor, which are used in SAS control, and the maximum speed is controlled in range from unlimited speed to approximately 8 km/h depending on the weight of loads when the height switch detects high side.

Note:

- When the maximum speed limit is disabled, the sudden acceleration is suppressed until the accelerator pedal is stepped off, or until the speed becomes stable.
- In case that the vehicle speed has already exceeded the maximum speed, it is gradually decreased and limited to the maximum speed.
- If the maximum speed limiter and/or low speed setting has been set, the lowest limit speed is adopted including the limit speed of this feature.

Lift-height and load-sensing acceleration and deceleration control

This feature can improve the stability while driving with the heavy load at the high lift position, by limiting the acceleration (deceleration) depending on the load.

For example, it can reduce the possibility of falling of loads, in operational errors that the accelerator pedal has been suddenly stepped on (off) or that the direction switch has been shifted while the accelerator pedal is fully stepped on.

Note:

- Because the deceleration limitation is released at the speed of less than 3km/h when the forklift approaches to the racks, it can be operated in ordinary feeling of the accelerator off regeneration brake.
- The deceleration limitation is also released when the switchback operation has been done, because it can be taken as the braking operation.
- Brake pedal operations always precede the deceleration limitation of Auto Speed Control.

Auto speed control indicator

The Auto Speed Control Indicator is displayed on the multi-function display while it is activating (1).

The indicator is also displayed for a while after the key switch is turned on (2) to inform that this feature is in available configuration.

If only acceleration/deceleration control is available (with speed control disabled by dealer), the indicator is shown with inverted colors.

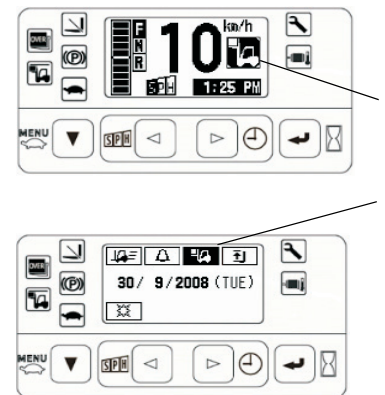

(1) (2) Auto speed control indicator with speed control disabled



Shock sensor (OPT)

When this feature detects the intense shock on the vehicle, it warns the operator with the buzzer sound, and it records its date and time into the memories in the multi-function display.

Because only the administrator can cancel the buzzer sounds, the operator necessarily must report it to the administrator. This is effective to suppress the rough operation.

Here, this feature can record the PIN into the memories in addition to the date and time when the option "PIN Entry" is taken simultaneously. It becomes easier to identify the operator who has made the intense shock.

⚠ Warning

- The strength of the shock generated on the vehicle depends on the objects where the vehicle collided. Not all of the collisions can be detected.
- The shock generated in the usual operation depends on the road conditions, the loads, and the material handling operations.
- All the detected records may not be necessarily based on a actual collision. Please investigate the records in consideration of the possibility of erroneous detections in the usual operation in addition to actual collisions.

Initial screen after key-on

Shock sensor icon is displayed on the initial screen of the multi-function display after the key switch is turned on (1), and it informs of installation and activation of this feature.

Measurement of shock

The menu "MEAS./SETTING" can help to determine the appropriate setting values by displaying the momentary generated shock values and the detected peak shock values while measuring.

This screen is displayed by selecting the menu "MEAS./SETTING" by using the switch (1) and switch (4).

Pressing the switch (1) "CLR" or re-entering this screen can clear the detected peak shock values to zero.

Note:

Measured values does not perfectly accord with the acceleration of the generated shock on the vehicle.

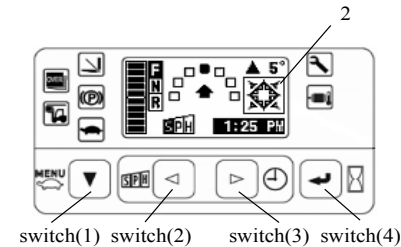

Shock detection and alarm operation

If the detected shock exceeds the preset alarm value on either front-back or lateral direction while the vehicle is operating, the "Shock Alarm" icon and buzzer-sound alarm the operator (2).

The alarm continues as long as the key-switch is turned on with the battery connected until an administrator resets it, even if the operator turns the key-switch off or disconnects the battery.

The detected shock values, date and time are recorded on the multi-function display at the moment of the detection.

In the case of the model with "PIN code entry system" (OPT), PIN is also recorded.

Note:

In case of warning alarm sounds, an operator should ask manager to reset the alarm.

Auto-off function

If the operator turns on the key switch and leaves the vehicle, the vehicle turns off after 1 min, thus preventing waste of energy.

To restart the vehicle, turn off the key switch, and then, turn it on.

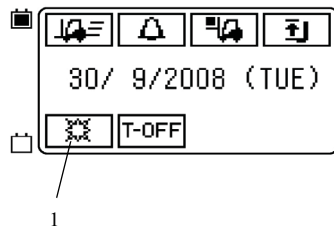



SWITCHES AND LEVERS

Key switch

Insert the key with the teeth facing upward.

- OFF..... The key can be inserted and pulled out in this position.
- I ON..... Turn the key in a clockwise direction from the OFF position. The vehicle is ready to start when the key is in this position.

⚠ Caution

- **Be sure to sit in the seat before turning the key switch to ON. If the OPS indicator is displayed on the screen, release the accelerator pedal and return all levers to their neutral positions. Make sure that the OPS indicator goes off.**
- **Do not turn the key switch to ON while depressing the accelerator pedal.**
- **Remove the key switch when the vehicle is not in use.**

Note:

When the key switch is turned off, the forks will not lower even if the lift lever is shifted downward (Key-lift interlock).

Turn signal switch (OPT)

This switch causes the turn lamps to blink.

Left turn push the lever forward

Right turn pull the lever backward

The turn signals will operate even when the key switch is off. The turn signal switch returns automatically to the original position after a direction change.

Light control switch (OPT)

This is two-stage turning switch. The lights indicated by "○" in the table below light up at each turning position

Light name	Step 1	Step 2
Tail lamp (OPT)	○	○
Headlight (OPT)	—	○

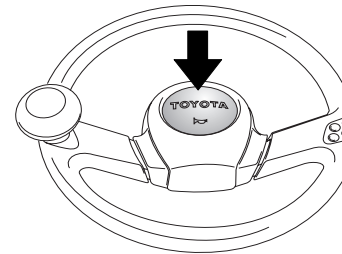
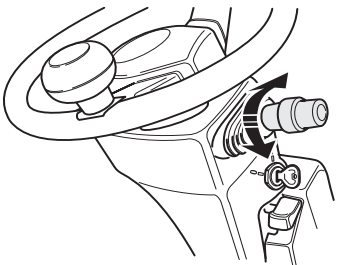
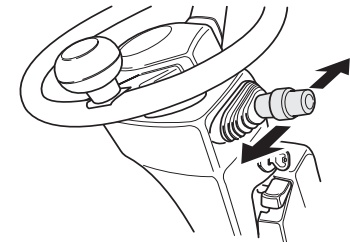
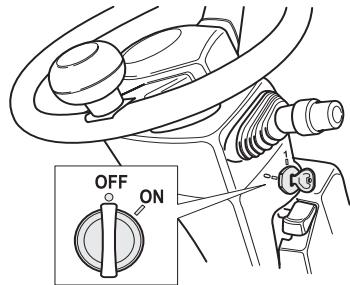

Horn button

Press the button in the center of the steering wheel to sound the horn.

ARMREST

Note:

If the OPS indicator is displayed on the screen, release the accelerator pedal, return all levers to their neutral positions and return to the seat. Make sure that the OPS indicator is off.

Direction lever

This lever selects forward or backward travel.

The neutral position is between the forward and backward positions.

Forward Push the lever forward

Backward Pull the lever backward

Push the lever in the direction opposite to the traveling direction, and depress the accelerator pedal to activate the electric brake for smooth braking.

⚠ Caution

- **Operate the electric brake carefully when the forks are loaded.**
- **Stop the vehicle when shifting to forward or reverse.**
- **If the OPS indicator is displayed on the screen, release the accelerator pedal, return all levers to their neutral positions and return to the seat.**
- **There is no direction lever for D2 pedal and Double Accel pedal, because these pedals have switch at acceleration pedal.**

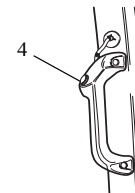
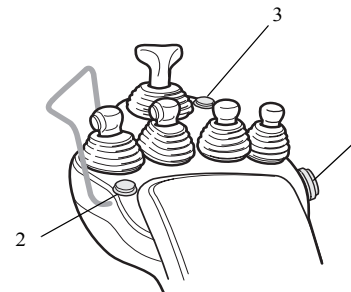
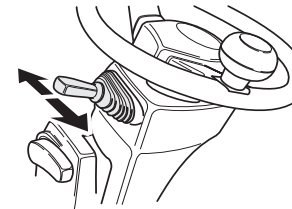
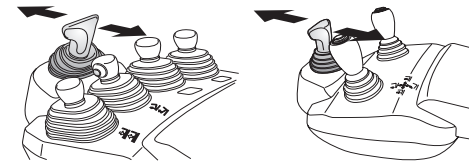

Emergency stop button (OPT)

In the event of an emergency, press the emergency stop button (1) to disconnect power and stop all vehicle movement (drive and lifting). Pull the button out again to reset it and restart work.

Do not use the emergency stop button as a power switch to turn the forklift off.

Horn button (OPT)

Press the button (2) to sound the horn.

Rear assist grip with horn button (OPT)

The rear assist grip with the horn button (4) can be easily turned on while back running.



Height limiter (OPT)

Press the button (3) to set ON/OFF the forks height limiter. When the height limiter is ON, forks can't be raised over the pre-set height limit, and a buzzer will warn the operator if the limit is reached.

Mini-lever

Lift lever

Raises and lowers the forks.

Raise Pull the lever

Lower Push the lever forward

Raising and lowering speed are controlled by the angle of this lever.

Note:

- The forks cannot be lowered even if the lift lever is so operated if the key switch is off. (Key-lift interlock)
- When the forks cannot be lowered due to operation failure, loosen the lift lock release bolt (1).
- When the forks have been lowered by using the lift lock release bolt, be sure to retighten the bolt to its original position.

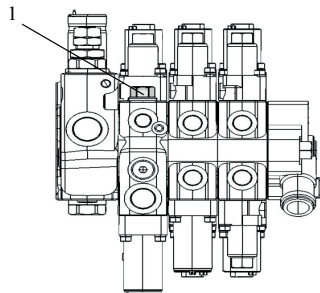
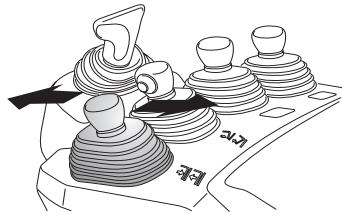

Tilt lever

This lever tilts the mast forward and backward.

Forward Push the lever forward

Backward Pull the lever

Forward and backward tilting speed are controlled by the angle of this lever.

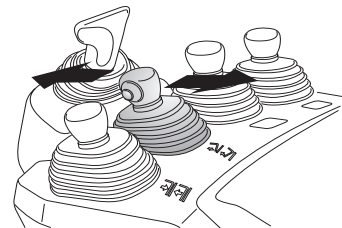

Attachment levers

These levers operate an attachment. Attachment speed is controlled by the angle of the levers.

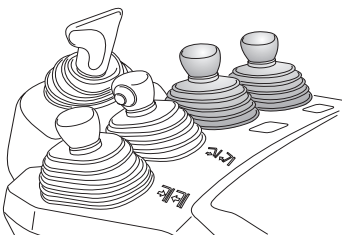

Joystick (OPT)

Load handling joystick

Lateral and push-pull operations correspond to lifting up/down and tilting, respectively.

Raise Operate the joystick rightward.

Lower Operate the joystick leftward.

Forward tilting Push the joystick.

Backward tilting Pull the joystick.

Operating in an oblique direction is possible for simultaneous lifting and tilting.

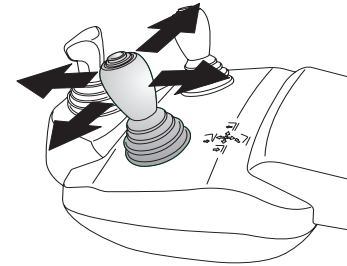

Note:

- The forks cannot be lowered even if the lift lever is so operated if the key switch is off. (Key-lift interlock)
- When the forks cannot be lowered due to operation failure, loosen the lift lock release bolt.
- When the forks have been lowered by using the lift lock release bolt, be sure to retighten the bolt to its original position.

Attachment operating joystick

Lateral and push-pull operations correspond to the third and fourth mini-lever operations, respectively.

Oblique operation, however, is not possible.

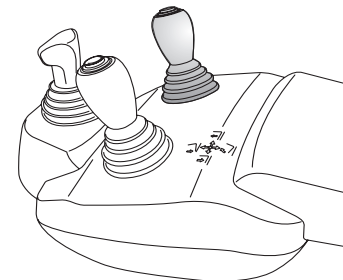



Fork automatic leveling switch

If changing mast tilting from backward to forward while pressing this switch, the mast will be stopped automatically when the forks is level. This switch can be also used to slow down the backward tilt speed at a low lift.

Automatic fork leveling control

When the forks are tilted backward, use the tilt lever to tilt the mast forward while pressing the forks automatic leveling switch to stop the mast automatically when the forks are horizontal. This feature is convenient when inserting and withdrawing the forks while stacking.

Fork motion when changing mast tilting from backward to forward while pressing the forks automatic leveling switch:

	Not loaded	Loaded
High lifting height	Fork stopped in horizontal position (mast vertical) Not tilting forward	Not tilting forward
Low lifting height	Fork stopped in the horizontal position (with mast in the vertical position)	
Lift to the maximum height	Not tilting forward	

Active mast backward tilt speed control

The backward tilt speed can be slowed down by pressing the forks automatic leveling switch. However, backward tilt speed will automatically be slowed at a high lift whether or not the switch is pressed.

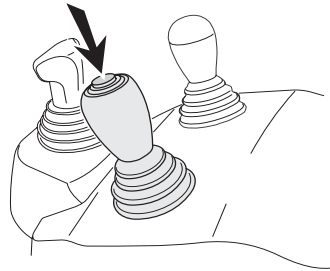
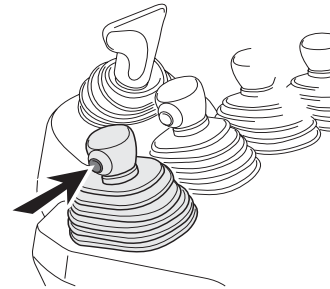
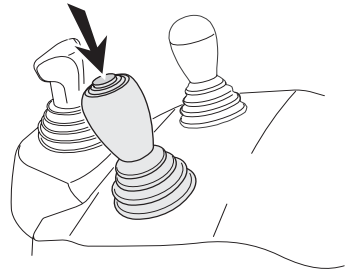
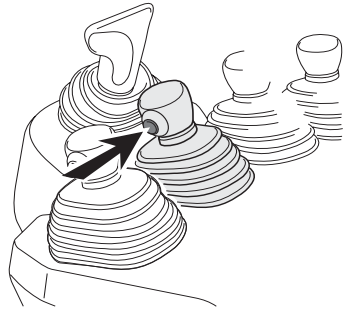

Automatic height control (OPT)

Note:

- Automatic height control is part of the Height selector option.
- This feature requires the setting of favorite height positions. See "Height Selector".

With the lift lever set to neutral, briefly press the switch 1-2-3 times to select the favorite position (from lower to higher). A fourth push will restore the normal lifting function.

Activating this feature forbids the forks to raise over the favorite height set. Attempts to raise the forks over the limit will cause a buzzer to sound.

Note:

- Activating this feature while forks are already over the favorite height, will allow only lowering movement until the parameter set is reached.
- When the Height Limiter is ON, favorite height positions over the limit set aren't available.
- In joystick models, the height selector switch is disabled during tilting operations.
- Lift-blocking devices (such as the OPS system) will turn OFF the Automatic height control
- On joystick models, favorite height can't be selected during tilting operations. Doing so activates the auto-leveling function.

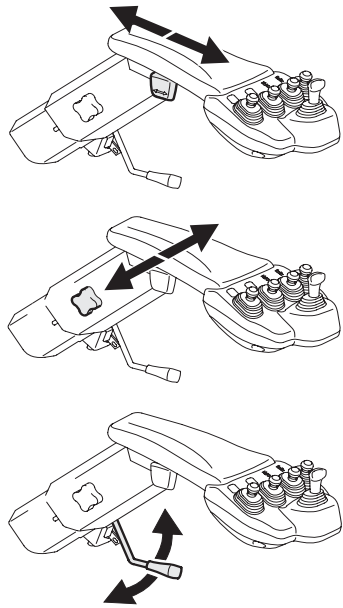

Armrest position adjustment

Before operating the vehicle, adjust the armrest until the correct operating posture that matches that of the operator is reached.

1. Forward/backward position adjustment
Loosen the forward/backward position adjustment knob by pulling it up, then adjust the front and back positions. After adjusting, push the forward/backward position adjustment knob to fix it at its original position.
2. Height position adjustment
Loosen the height position adjustment knob in a clockwise direction and wiggle up and down to move.
3. Tilting position adjustment
Loosen the turn-lock lever by pulling it up, then adjust the tilting position. After adjusting, push the turn-lock lever to fix it at its original position.
This lever is used to turn the mini-lever box when opening and closing the seat stand for battery replacement.

⚠ Caution

- After adjusting the forward/backward, height and tilting positions of the armrest, be sure to confirm that the knobs and the lever are securely fixed. If the knob and lever becomes loose during operation, an operational mistake could occur.
- Do not adjust the position of the armrest during traveling or material handling operation.

Parking brake lever

When parking the vehicle, pull the parking brake fully while depressing the brake pedal. To activate the brake, pull the lever to position B. When released, it returns to the parking position C. To release the brake, pull the lever once and keep the knob at the top of the lever grip pushed, to return the lever to the original position A.

⚠ Caution

- Be sure to depress the brake pedal when operating the parking brake.
- When operating the lever, hold only the grip of the lever.
- Always chock the wheels when parking on a slope.
- If you fail to release the parking brake and travel, it may deteriorate the braking effect. Have the vehicle inspected at a Toyota dealer.

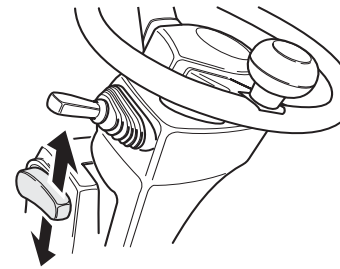
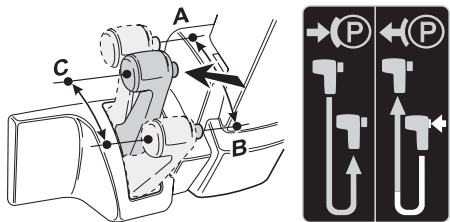

Tilt steering adjustment

1. The steering wheel position may be adjusted back and forth while the tilt steering adjust lever is raised.
2. Push the adjust lever up to fix the steering wheel at the adjusted position.
3. After the adjustment, try to move the steering wheel back and forth to make sure that it is locked into position.

⚠ Caution

Always adjust the steering wheel position before traveling. Never adjust the steering wheel position during traveling.

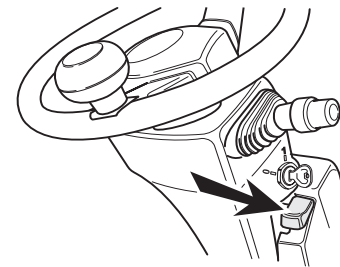

Steering Lock

The steering lock allows the steering column to tilt forward. It is different from the tilt steering adjustment, because the steering column can only be pulled back to the original position.

This is useful for operations like battery hood opening, when the operator needs to tilt forward the steering column, but wishes to keep the tilt adjustment for an optimal drive position.

Push the steering lock lever to unlock the steering column and tilt it forward.

Pull the steering column back until it clicks, locking in the original driving position.

Brake pedal

Apply the brakes carefully when the forks are loaded. Always release the accelerator pedal before applying brakes.

Standard accelerator pedal

This pedal controls speed.

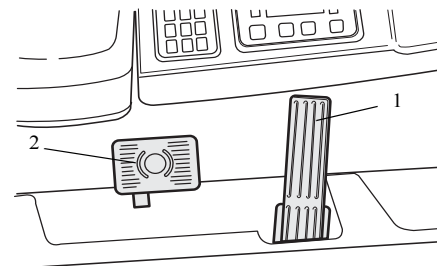

- (1) Accelerator pedal
- (2) Brake pedal

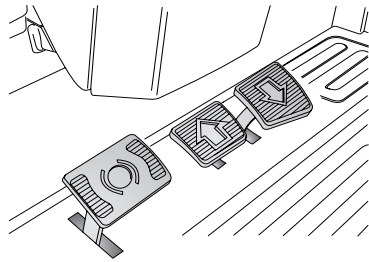

D2 pedal (OPT)

This pedal adjusts the forward/backward traveling and controls accelerator.

Forward Step on the left side of the forward traveling pedal

Backward Step on the right side of the backward traveling pedal

Speed can be adjusted by the pedal depression.

⚠ Caution

- **Slow down before adjusting the forward/reverse traveling.**
- **Before turning the key switch ON, be sure to pull the parking brake.**
- **When the parking brake is released, the forklift can be operated.**

Note:

If the OPS indicator is displayed on the screen, return to the seat and release the accelerator pedal. Make sure that the OPS indicator is off.

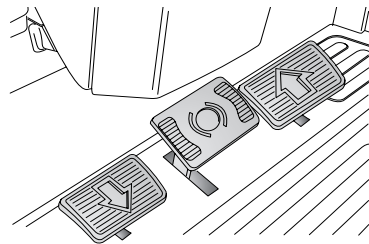

Double Accel pedal (OPT)

This pedal adjusts the forward/backward traveling and controls accelerator.

Forward Step on the right traveling pedal

Backward Step on the left traveling pedal

Brake Step on the center pedal

Speed can be adjusted by the pedal depression.

⚠ Caution

- **Slow down before adjusting the forward/reverse traveling.**
- **Before turning the key switch ON, be sure to pull the parking brake.**
- **When the parking brake is released, the forklift can be operated.**

Note:

If the OPS indicator is displayed on the screen, return to the seat and release the accelerator pedal. Make sure that the OPS indicator is off.

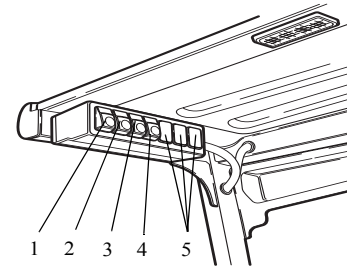

Switch compartment

1. Rear work light switch (OPT)
2. Front wiper switch (OPT)
3. Rear wiper switch (OPT)
4. Beacon lamp switch (OPT)
5. Spare

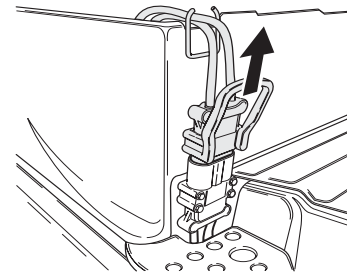

Battery plug

This plug connects the battery to each electric device. Set the key switch to the OFF position before disconnecting or connecting the plug.

Keep the battery plug connected unless it is necessary to disconnect it.

When connecting the battery plug, make sure that the battery cable is kept in the cable guard.

⚠ Caution

- **Disconnect the battery plug before inspecting the electrical systems.**
- **If any abnormality occurs during operation, disconnect the battery plug immediately.**
- **Do not disconnect the battery plug during current conduction as it may cause arcing or plug damage.**
- **When the battery is disconnected, pull the case of battery plug, don't pull the cables of battery plug.**



BODY COMPONENTS

Operator's seat

The operator's seat and seat belt are provided for your safety. Pull the slide lever up to move the seat back and forth.

⚠ Caution

- The seat switch function prevents traveling and load handling operations when the operator is not seated in the seat. Be sure to remain seated in the seat while in operation. Do not operate the vehicle with any objects placed on the seat. This will cause the OPS system to operate abnormally.
- Sitting incorrectly in the seat will make the steering heavy.
- The seat switch should be activated only by sitting in the seat.

Suspension seat

The seat suspension mechanism provides a comfortable seating position based on the weight of the driver. The optimum driving position can be set using the following knob and levers.

- (1) Seat slide lever
Pull the slide lever up to move the seat back and forth. The seat is locked in position when the lever is released.
- (2) Recliner adjust knob
Press the knob at the rear left to adjust the angle of the seat back.
- (3) Weight adjust knob
Turn the knob on the front right of the seat clockwise to adjust for a heavier body weight. Turn the knob counterclockwise to adjust for a lighter body weight. Adjustment can be made for body weights from 50 kg to 130 kg.
- (4) Seat belt

⚠ Caution

After adjustment, gently rock the seat forward and backward to confirm that the seat is firmly locked in position.

Pocket

A pocket for housing the operator's manual is provided on the rear side of the seat back. Push down the clip and pull the pocket to open it. If the manual is missing, be sure to ask a Toyota dealer for a copy.

Note:

Make sure the pocket is closed securely.

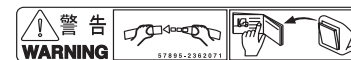
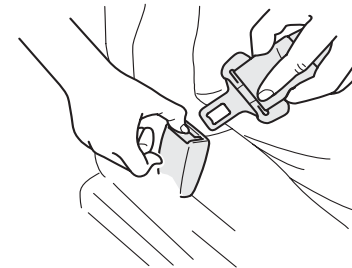
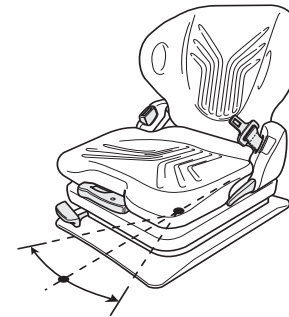
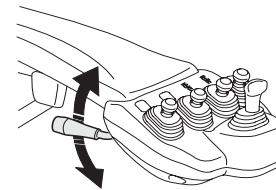
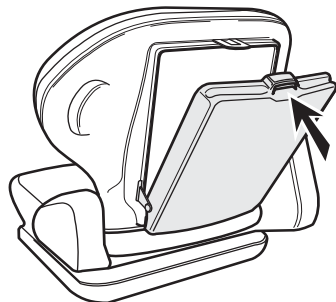
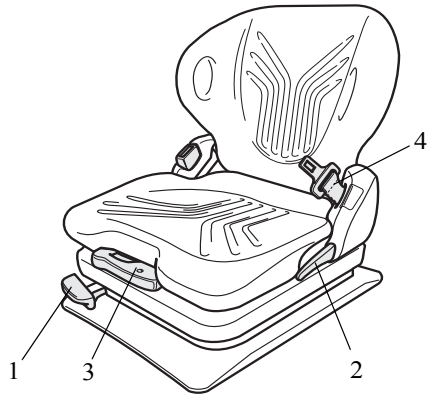

Swivel seat (OPT)

This option can improve posture and the view during backward driving. Also it supports getting off, because it rotate to the left and it expands space wider between pillar and seat back.

Pull the lock release lever upward to swivel the seat.

Seat can returned to neutral position by pulling it.

⚠ Warning

While rotating the seat, do not put hands etc. in range of rotation.

Seat belt

To fasten the seat belt, pull it out of the retractor and insert the tab into the buckle.

You will hear a click when the tab locks into the buckle. Pull the belt to make sure the buckle is securely latched.

The seat belt length automatically adjusts to your size. To release, push the release button and allow the belt to retract.

⚠ Caution

Always fasten the seat belt during operation. Your seat and seat belt will reduce the risk of serious injury or death in case of a vehicle tipover. In a tipover, danger of serious injury or death is reduced if you stay with the vehicle in the operator's compartment.

Note:

If the seat belt is locked and cannot be drawn out any further, pull on the belt strongly once, then loosen it, then draw it back out slowly.

⚠ Warning

Always wear the seat belt when driving the vehicle. Vehicles can tip over if operated improperly. In order to be protected from the risk of serious injury or death in the event of a tipover, the operator must be held securely in the seat. The seat and seat belt will help maintain vehicle safety and safety in the operator's compartment. In the event of a tipover, do not jump off, but, grip the steering wheel, brace your feet, lean away from the direction of tipover, and stay in the vehicle.

Please always fasten your seat belt when operating the vehicle.



Battery hood - opening

8FBET15, 8FBEKT16, 8FBEKT18, 8FBEMT15

1. Set the mast in the vertical position.
2. Tilt the steering column forward to the foremost position (through steering column lock lever).
3. Move the seat forward to the foremost position. Incline the seat back forward to the foremost position.
4. Move the armrest forward to the foremost position. Pull the armrest up at the upmost position. Slide the armrest up.
5. Remove the battery hood catch.
6. Fully open the battery hood and hold it until checking that the battery hood is locked securely.

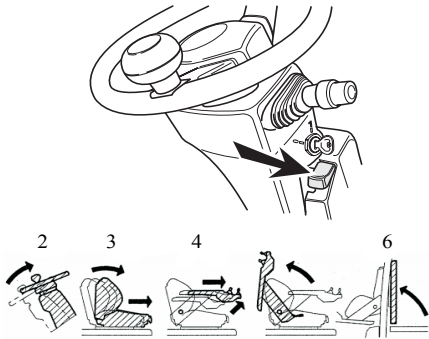

8FBET16, 8FBET18, 8FBET20 8FBEMT16, 8FBEMT18, 8FBEMT20

1. Set the mast in the vertical position.
2. Tilt the steering column forward to the foremost position (through steering column lock lever).
3. Move the seat forward to the foremost position.
4. Move the armrest back to the backmost position. Pull the armrest up at the upmost position. Slide the armrest up.
5. Unlock the battery hood catch.
6. Fully open the battery hood and hold it until checking that the battery hood is locked securely.

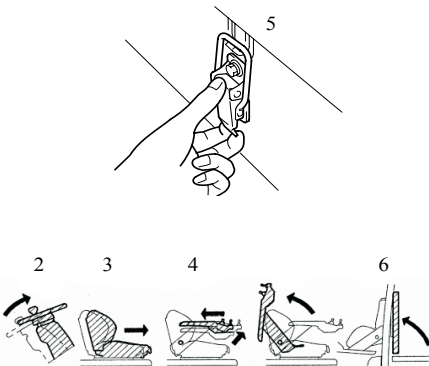

8FBET16, 8FBET18, 8FBET20 8FBEMT16, 8FBEMT18, 8FBEMT20 with Fork Pockets or Swivel Seat options

1. Set the mast in the vertical position.
2. Tilt the steering column forward to the foremost position (through steering column lock lever).
3. Move the seat forward to the foremost position.
4. Move the armrest back to the backmost position. Push the armrest down at the downmost position. Slide the armrest up.
5. Remove the battery hood catch.
6. Fully open the battery hood and hold it until checking that the battery hood is locked securely.

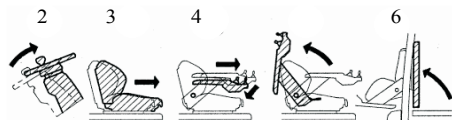

Battery hood - closing

Lift the battery hood and press the damper stay lock release button. Check that the battery cable is kept in the cable guard and then close the battery hood, locking the catch. Pull the steering column back to the original position.

⚠ Caution

Operating the vehicle without firmly locking the battery hood is very dangerous. Be sure to check that it is firmly locked before operating the vehicle.

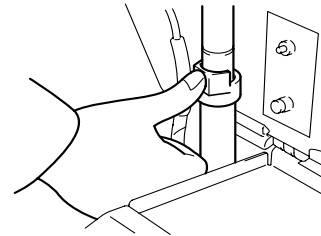

Fork

Lift each fork stopper and unlock so that the forks can be shifted left and right. Adjust the forks in the position most appropriate for the load. When adjusting the forks, make sure that the center of gravity of the load corresponds to the center of the vehicle. After adjustment, turn the stoppers to lock the forks in place.

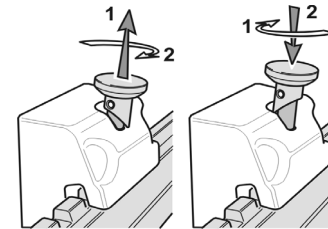

Draw bar

The draw bar is located at the back of the weight, and is used to pull the vehicle out if its tires drop into a gutter or become stuck in mud. The draw bar can also be used for loading the forklift onto another truck or vehicle. Never use the draw bar for towing the vehicle.

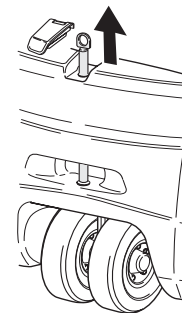

3W model

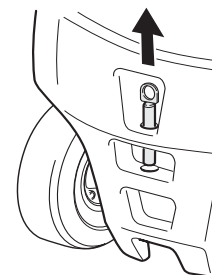

4W model

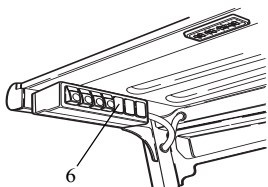
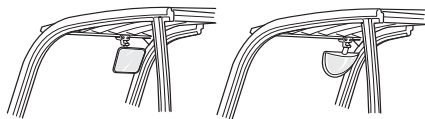
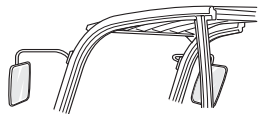
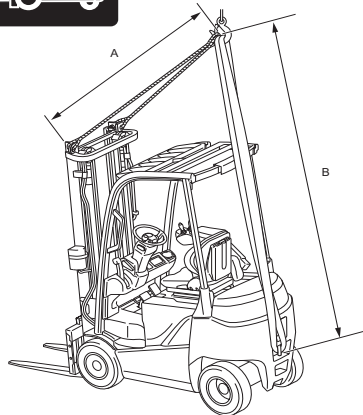

Hoisting the vehicle

To hoist the vehicle, sling a fiber belt or a wire rope at the side of the beam on top of the outer mast for the front side and at the draw bar for the rear side.

Note:

- Before hoisting the vehicle, tilt the mast to the most backward position.
- Please use protection pad at the roof end.
- Remove the rear combination lamp assembly before installing the protection pad.
- This illustration is showing the STD mast.
- Be careful not to strain the head guard.

A rope: use a fiber belt or wire rope

B rope: use a fiber belt

	3W	4W
Rope length A	Approx. 2m	Approx. 2m
Rope length B	Approx. 3m	Approx. 3.5m

⚠ Caution

- Before hoisting the vehicle, check that the draw bar doesn't move upward.
- If the draw bar moves upward, the vehicle should put down and the draw bar should be pushed to the correct position.
- Use fiber belt and wire rope of sufficient strength.
- Never use the holes on the upper side of the counterweight to hoist the vehicle.

Rear view mirrors (OPT)

Set mirror angles before vehicle start.

⚠ Caution

Do not rely only on mirrors while traveling backward.

Room light (OPT)

The switch (6) turns the room light on/off.

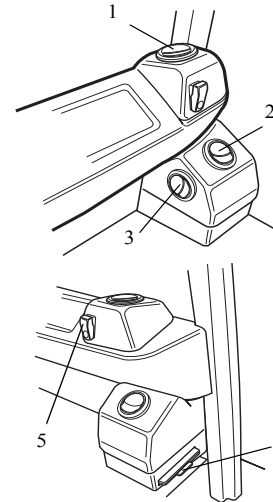

Heater (OPT)

Operator can adjust the direction of air by registers.

- (1) upper register / defroster
- (2) middle register
- (3) lower register
- (4) air filter
- (5) heater fan switch

Switch positions:

- 1 fan OFF, heater OFF
- 2 fan ON, heater OFF
- 3 fan ON, heater ON

⚠ Caution

Before starting the fans and heater, check if the air filter is installed.

Cabin and body guard (OPT)

Be sure to close the side doors / gates before traveling.

⚠ Caution

Check the conditions of the side doors / gates and locks. If any anomaly is found, have the vehicle inspected at a Toyota dealer.

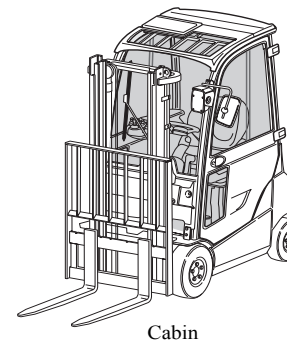

Cabin

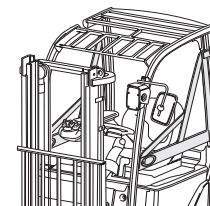

Body guard



BATTERY

Cautions concerning battery use

1. Do not overdischarge.
The battery charge indicator on the display blinks to inform the timing for charging when the charge drops below 20%. Charge the battery as soon as possible.
2. Avoid open flames.
The battery contains explosive gas. Keep away from open flames.
3. Do not let the electrolyte run out.
Only the water content of the fluid (diluted sulfuric acid) decreases when the battery is charged. Before charging, add distilled water (purified water) up to the specified level and reinspect the fluid level one hour after charging is complete.

Note:

When using a local battery, contact your Toyota dealer for information.

4. Keep the battery clean.
Especially, keep the battery top clean and dry. Keep the vent caps tightly closed.

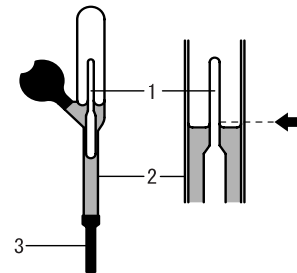
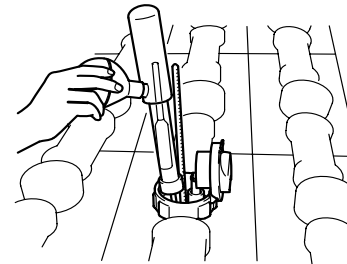
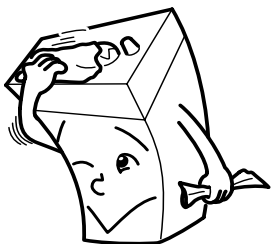
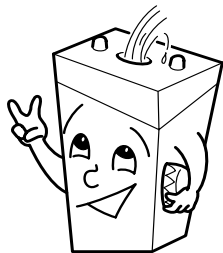
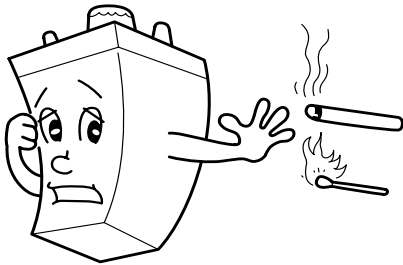

- (1) Hydrometer
- (2) Outer tube
- (3) Nozzle

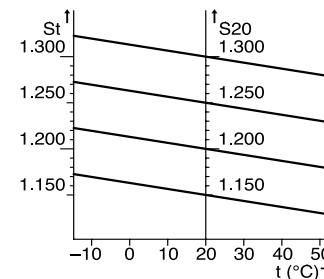

Specific gravity inspection

Perform specific gravity inspection following the manufacturer's instruction.

(Reference)

Perform specific gravity inspection at least once a week, and check that proper charging is done and that there is no extreme difference in specific gravity in the battery cells.

Specific gravity after charging 1.280 (20°C)

Specific gravity after discharging 1.150 (20°C)

When the specific gravity is below 1.150 (at 20°C), be sure to charge until the specific gravity is up to 1.280 (at 20°C).

Check the fluid temperature with a thermometer and convert the measured specific gravity to the specific gravity at 20°C.

⚠ Caution

Records concerning the battery should be kept properly as references to understand the battery condition.

Relationship between fluid specific gravity and temperature

Specific gravity conversion equation

$$S20 = St + 0.0007 (t-20)$$

S20: Specific gravity at 20°C conversion

St: Measured specific gravity at t°C

t: Electrolyte temperature (°C) at the time of measurement

Electrolyte level inspection

⚠ Warning

When checking the electrolyte, make sure the vehicle is on a flat surface and carrying no load before removing the battery.

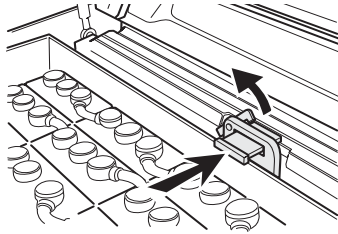

Battery replacement

1. Open the battery hood.
2. Disconnect the battery plug.
3. Remove the side hood.
4. Remove the vertical direction battery stopper to open.
5. Attach a hanger to the battery case and remove with a hoist.

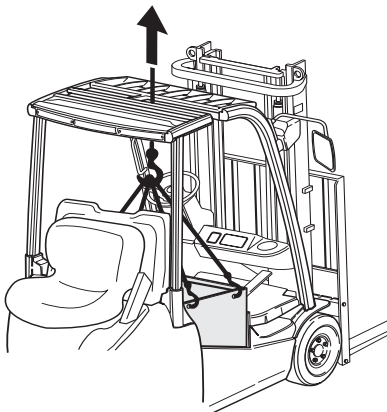

Battery replacement (Battery low lift-out model)

1. Open the battery hood.
2. Disconnect the battery plug.
3. Remove the side hood.
4. Remove the vertical direction battery stopper to open.
5. Attach a hanger to the battery case and remove with a hoist.

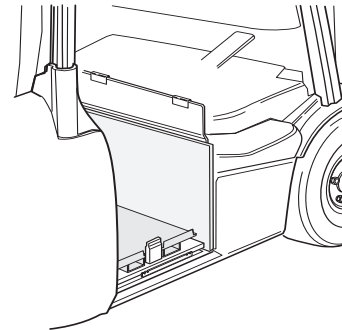
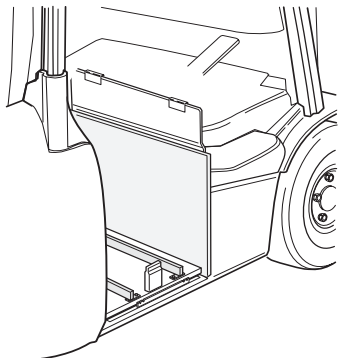

Battery replacement (Battery fork pocket model)

1. Open the battery hood.
2. Disconnect the battery plug.
3. Remove the side hood.
4. Remove the vertical direction battery stopper to open.
5. Replace the battery case by lifting and pulling the battery tray with another forklift truck.

Note:

- Check that the edge side of the battery tray doesn't go out of the battery.
- Insert the battery checking the white guide on the right rear side of the truck.

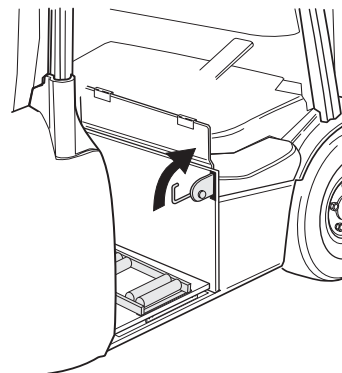

Battery replacement (Battery roll-out model, also with Hand Palette Truck)

1. Open the battery hood.
2. Disconnect the battery plug.
3. Remove the side hood.
4. Remove the vertical direction battery stopper and the width direction battery stopper to open.
5. Replace the battery case by using the battery puller system.





BATTERY CHARGING

Handling the battery

When the vehicle is to be withdrawn from use for two weeks or longer, all batteries should be fully charged and stored with the battery plug disconnected to avoid battery discharge. When the vehicle is to be stored for a further period, the battery should be charged regularly every two months.

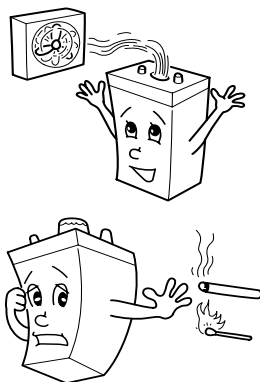

Caution during charging

Hydrogen, which is a highly combustible gas, is produced during charging. Be careful of the following points.

1. Charge in a well-ventilated open area, away from open flames.
2. Keep the battery hood open.
3. Keep away from open flames. Post a danger sign.
4. If you are using a vehicle with a cabin (Option), fully open the doors, rear window, etc. of the cabin before charging the battery.
5. Avoid lifting or tilting operation.
6. Do not start the vehicle.

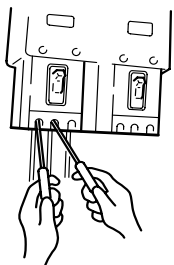

Caution for charging

1. Refer to the service data for the number of AC power fuses and breakers.
2. Charge the battery as soon as possible after operating the vehicle.
3. When the vehicle is not in use, it is not necessary to charge daily.
4. Perform equalization charge of the battery at least once a month, even when the vehicle is not in use.
5. Inspect the specific gravity and the fluid level once a week.



PRE-OPERATION CHECK

Item	Inspection
Previously detected malfunctions	Correct.
Exterior	Vehicle posture; oil leakage; water leakage; loose sections; exterior damage.
Wheels	Tire inflation pressure; wear or damage; rims; hub nuts.
Lights	Light condition; cracked.
Hydraulic oil	Oil level; contamination; viscosity.
Brake pedal	Braking action
Parking brake	Braking action
Steering wheel	Looseness; play; vibration; pulling.
Horn	Sound.
Instruments	Functioning.
Material handling system	Function of each section; oil leakage; cracking; looseness; SAS
Motor	Abnormal noise; rotation.
Battery	Charging.
Operator restraint	Cut, frays and deck latch OK; seat belt & buckle

Pre-operation checks and weekly inspections are the responsibility of the Toyota industrial vehicle user.

Be sure to perform a pre-operation check before beginning work to insure safety.

⚠ Warning

If any abnormality is found, or when the diagnosis operation indicator blinks, or an error code appears on the display, stop operation immediately and have the vehicle inspected at a Toyota dealer.

WALKAROUND INSPECTION

Vehicle posture

Does the vehicle excessively lean to one side or the other? If so, check for a flat tire puncture or problem with the undercarriage.

Beneath the vehicle

Check for any oil or water leakage on the ground or floor where the vehicle was parked. Check for loose sections or damage.

If anything unusual is found, have the vehicle inspected at a Toyota dealer.

Tire inspection

Always maintain proper tire pressure. Low pressure shortens tire life and increases electric power consumption. A difference in right and left pressure will make steering difficult.

Turn the valve cap to the left and remove it. Use a tire pressure gauge to check the pressure and adjust to the specified level. Refer to the service data for the specified tire pressure.

After checking the pressure, make sure there is no air leaking from the valve, then retighten the valve cap to the original position.

If there is any difference in tire wear between the front and rear or left and right tires, or if damage or a bent rim is found, have the vehicle inspected at a Toyota dealer.

⚠ Caution

Since industrial vehicle tires use high-pressure air, misshaped or cracked rims are extremely dangerous. Never exceed the specified pressure. Failure to regulate the air compressor before inflating tires is dangerous. Tire pressure exceeding the specified pressure will cause the tire to explode.

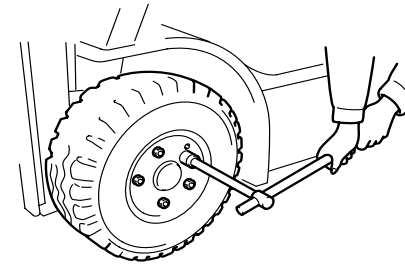

Hub nut inspection

Check the tightness of the hub nuts. Tighten all nuts uniformly. Refer to service data for proper torque.

Retightening of bolts and nuts

Retighten the bolts and nuts on the chassis and material handling system.

Greasing mast and steering linkage

Sufficiently grease the chains, steering linkage, etc. in accordance with the lubrication table.

Note:

- Clean the grease fitting tips thoroughly before greasing.
- After greasing, wipe off excess grease.

Light inspection

(Rear view mirror, headlamp and turn signal light are optional)

Make sure that the filament is not damaged and inspect the lens. Always keep the lenses clean to insure proper forward vision.

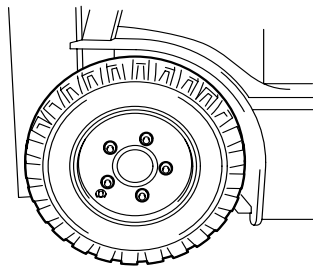
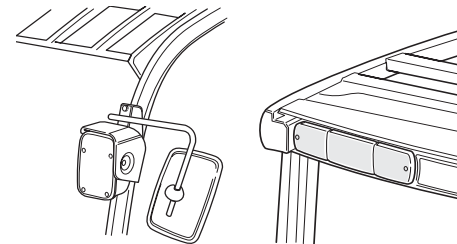

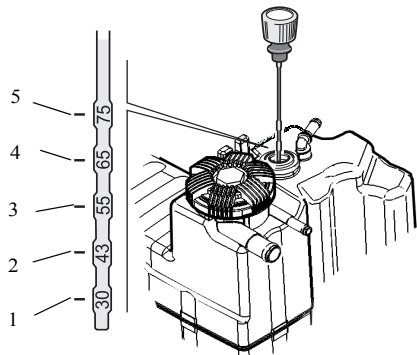

- (1) Level line: At the maximum level line of forks, ≤ 4000 mm
- (2) Level line: At the maximum level line of forks, 4001 to 5000 mm
- (3) Level line: At the maximum level line of forks, 5001 to 6000 mm
- (4) Level line: At the maximum level line of forks, 6001 to 7000 mm
- (5) Level line: At the maximum level line of forks, 7001 to 7500 mm

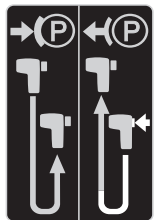
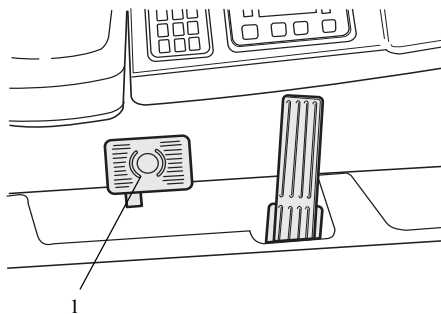

ON BOARD VEHICLE INSPECTION

Hydraulic oil level inspection

Park the vehicle on a level surface and lower the forks to the ground before checking the level of the hydraulic oil.

1. Remove the oil cap.
2. Wipe the level gauge attached to the oil cap with clean cloth, and insert it again into the tank.

Note:

The oil level must be checked with the oil cap in contact with the retainer inlet.

3. Extract the level gauge gently and check that the oil adhesion is up to the level line.

Note:

The oil level varies with the maximum lifting height.

4. If the oil level is insufficient, add oil. Spilled or splashed oil must be wiped off thoroughly.

Brake pedal inspection

1. Depress the brake pedal (1) fully, and check that a sufficient reaction can be felt.
2. When the pedal is kept depressed, make sure that it does not sink any further.
3. Also check that no abnormality of pedal depression and return movement is observed.
4. If abnormality of pedal depression is found, have the vehicle inspected at a Toyota dealer.

Parking brake inspection

Pull the lever and check if the parking brake is active. Return the lever to the original position and check if the parking brake is released.

⚠ Warning

If an abnormality is found, have the vehicle inspected at a Toyota dealer.

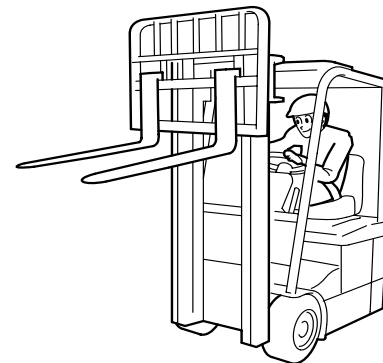
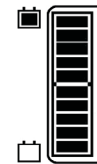
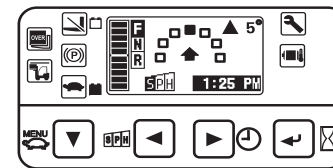

OPS indicator inspection

Sit in the seat, and turn the key switch to ON. Make sure that the OPS indicator is not displayed on the screen.

⚠ Caution

In any of the following cases, stop operation and have the vehicle inspected by your Toyota dealer:

- The OPS indicator is not displayed on the screen when the operator leaves the seat.
- The OPS indicator does not turn off when the operator returns to the seat.

Inspection of measuring instruments

Measuring instruments are indispensable for understanding the vehicle status during operation. Turn the key switch to ON to check the normal functioning of each instrument.

Battery inspection

1. Perform the inspection after turning the key switch to ON.
2. Check the battery charge indicator on the display to see if the battery charge is sufficient.

Material handling system inspection

1. Check the forks for the installation position, cracks and bending.
2. Check for mast distortion, chain tension and oil leakage from cylinders and piping.
3. Operate the lift and tilt levers to check their functioning.

Note:

- Be sure to perform full-stroke operation for each cylinder piston a few times before starting daily operation.
- If any abnormality is found, have the vehicle inspected at a Toyota dealer.

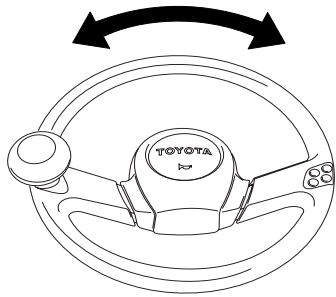

Steering wheel inspection

Note:

Perform the inspection after turning the key switch to ON.

1. Check the steering wheel play after setting the rear wheels in the straight travel position.

Note:

See the service data for the standard steering wheel play.

2. Turn the steering wheel and move it up and down to check that there is no looseness.
3. If any abnormality is found, have the vehicle inspected at a Toyota dealer.

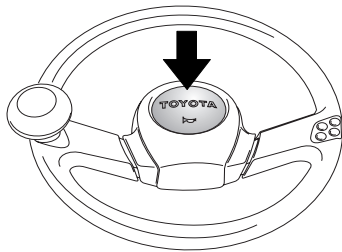

Horn inspection

Press the horn button to see that the horn sounds normally.

WHILE TRAVELING SLOWLY

Brake performance

Depress the brake pedal, and see if there is any abnormality in braking performance or if the brake is applied only on one side.

Pull the parking brake lever to see that the vehicle is stopped and that the parked position is maintained.

Motor inspection

Drive the vehicle to check the motor for smooth running without any abnormal noise.

Also operate the material handling levers to check the pump motor.

Steering inspection

While moving the vehicle slowly in a safe location, turn the steering wheel to the left and right and check for any unusual movement.

SAS system inspection

Check the SAS system to make sure that it is functioning properly.

Load handling system inspection

Check the mast to make sure that it can be properly tilted forward and backward and raised up. Also, make sure that the mast can automatically stop at its horizontal position.

BEFORE GARAGING THE VEHICLE

Remove dirt from all vehicle components and then perform the following:

1. Inspect for oil or water leakage.
2. Inspect each component for warping, scratches, dents, or cracks.
3. Lubricate each component.
4. Fully raise and lower the forks to lubricate the inside of the lift cylinder.
5. If you sense anything unusual during operation, notify your supervisor.

⚠ Caution

Even a small erroneous operation can cause a serious accident. Do not operate the vehicle until repairs have been completed.

WEEKLY MAINTENANCE

Add the following items to the pre-operation inspection items. Have necessary adjustments and replacements performed at a Toyota dealer.

Weekly (every 40-hour) inspection items	
Battery electrolyte.....	Level check and distilled water addition
Battery electrolyte.....	Specific gravity check
Bolts and nuts	Retightening
Mast and steering linkage	Greasing MP grease
Chain lubrication	Engine oil

Maintenance required for the above items are mainly checking and addition. As oil or grease needs periodic replacement depending on the degree of contamination, take proper action as required.

Never fail to perform pre-operation inspection and weekly maintenance to maintain safe, comfortable operation.



SELF SERVICING

Tire replacement

⚠ Caution

- After jacking up the vehicle, never enter the area under the forks and frame. Serious injury may occur if the jack happens to be removed accidentally.
- As the tire pressure for the forklift tires is set at a high level, adjust the tire pressure, paying special attention to deformation or cracking of the rim of the replaced tire. Never adjust the pressure beyond the specified level.
- See the service data for the hub nut tightening torque.
- A pneumatic tire is optional setting.



Front wheel

1. Park the vehicle on a level surface.
2. Apply the parking brake and chock the wheels. Tilt the mast backward, raise the forks by about one meter, and insert the jack under the jack-up point.
3. Jack up the vehicle until the tires are about to leave the ground and loosen the hub nuts.
4. Jack up the vehicle until the tires leave the ground. Remove the hub nut and wheel. For pneumatic tires (OPT), completely release the air pressure from the tire before removing the hub nuts.
5. To reinstall each wheel after replacing the tire or repairing flat tires, operate in the reverse order of the procedure for removal. The hub nuts should be tightened evenly in the sequence shown in the figure. For pneumatic tires (OPT), check and adjust tire pressure after installing each wheel.

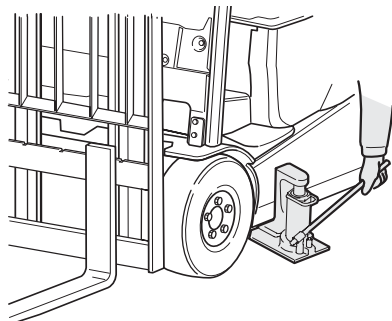

⚠ Caution

- Repeatedly drive forward and backward 2 to 3 times and check for looseness of hub nuts, if necessary, retighten the nuts.
- Refer to the service data for appropriate tire pressure.

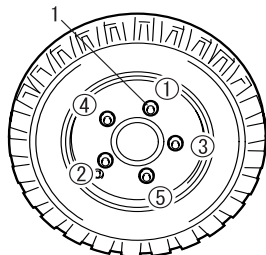

(1) Hub nuts

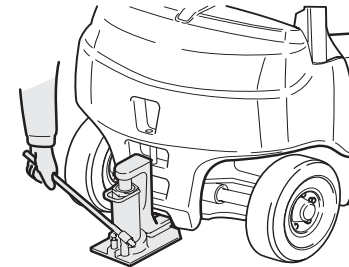
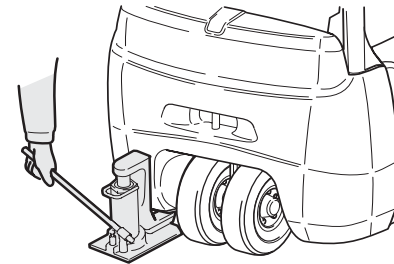

Rear wheel

1. Park the vehicle on a level surface and turn the rear wheels 90°.
2. Apply the parking brake and chock the wheels. Insert the jack under the weight (jackup point).
3. Jack up the vehicle until the tires are about to leave the ground and loosen the hub nuts.
4. Jack up the vehicle until the tires leave the ground. Remove the hub nut and wheel. For pneumatic tires (OPT), completely release the air pressure from the tire before removing the hub nuts.
5. To reinstall each wheel after replacing or repairing the tires, operate in the reverse order of the procedure for removal. The hub nuts should be tightened in the same sequence as that for the front wheels.
6. For pneumatic tires (OPT), check and adjust tire pressure after installing each wheel.

⚠ Caution

- Repeatedly drive forward and backward 2 to 3 times and check for looseness of hub nuts, if necessary, retighten the nuts.
- Refer to the service data for appropriate tire pressure.

Note:

See the service data for the hub nut tightening torque.

Fuse replacement

When lights do not light or electrical system devices do not function, the respective fuse may be blown. See if the fuse for each device is blown. The fuses are located in the contactor panel at the rear right of the vehicle.

Note:

Each fuse corresponds to the following devices:

- 1)..... F1 (drive)
- 2)..... F4 (lamp)
- 3)..... F5 (control circuit)
- 4)..... F6 (control circuit)
- 5)..... F7 (fan and solenoid)

⚠ Caution

- Always replace with a fuse with the same capacity.
- If the new fuse is blown immediately after replacement, ask Toyota dealer for inspection.
- When the fuse is being replaced, never short between terminals.

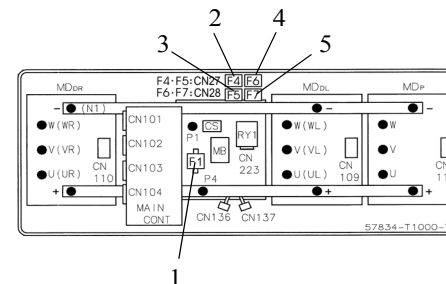



PERIODIC MAINTENANCE

Periodic inspection and maintenance are necessary to keep your Toyota industrial vehicle running smoothly. The designated number of hours (when the truck is ON) for each inspection cycle is as follows.

Daily (pre-operation check)Every 8 hours

WeeklyEvery 40 hours

6-weekEvery 250 hours

3-monthEvery 500 hours

6-monthEvery 1,000 hours

12-monthEvery 2,000 hours

If operating hours in 6 weeks exceed 250 hours, perform inspection according to the operating hours specified in the periodic inspection guide. Pre-operation checks and weekly inspections should preferably be performed by the user. 6-week, 3-month, 6-month and annual inspections should be performed at a Toyota dealer, as high skill and special tools are required.

Refer to the periodic maintenance table to determine inspection and maintenance items and inspection cycles.

Use only genuine Toyota parts for replacement, and use the recommended types of lubricants.

PERIODIC REPLACEMENT TABLE

Periodic Replacement Table

REPLACEMENT CYCLE (Based on total operating hours or months, whichever comes first)	EVERY	6 WEEKS	3	6	12	18	months
	EVERY	250	500	1000	2000	3000	hours
Hydraulic oil				●	←	←	
Hydraulic filter		●*				●	
Air filter of hydraulic oil tank cap		●*				●	
Drive unit oil				●	←	←	
Wet disc brake oil						●	
Wheel bearing					●	←	
Power steering hose				(Every 2 years)			
Power steering rubber parts				(Every 2 years)			
Material handling system hose				(Every 2 years)			
Chain				(Every 3 years)			

*: For new vehicles

Note:

In case of the hard operating condition, the service interval of 170 hours or 1 month may be recommendable.

PERIODIC MAINTENANCE TABLE

Periodic Maintenance

INSPECTION METHOD

I: Inspect, correct and replace as required. T: Tighten. C: Clean. L: Lubricate. M: Measure and correct, and adjust as required.

REPLACEMENT CYCLE (Based on total operating hours or months, whichever comes first)	EVERY	6 WEEKS	3	6	12	months
	EVERY	250	500	1000	2000	hours

ELECTRICAL SYSTEM

Motor

Rotation sound.....	I*	I	←	←
Terminal looseness.....		T	←	←
Insulation resistance.....		M	←	←

Battery

Charging level.....		I	←	←
Electrolyte level.....		I	←	←
Electrolyte specific gravity.....		M	←	←
Terminal looseness.....		I	←	←
Abnormality in the upper portion of the battery and/or the case.....		I	←	←
Insulation resistance.....		M	←	←
Voltage measurement of each battery cell after charging.....				M

Magnetic switch

Contact looseness, damage, abrasion.....		I	←	←
Auxiliary contact operating, condition, contamination, and abrasion.....		I	←	←
Mounting condition of the arc shooter.....				I
Operating condition and timings.....				I
Looseness of the coil mounting locations.....				I
Mounting condition and looseness of the main circuit lead wire.....				I

Microswitch

Operating condition and timings.....		I	←	←
Installation damage and looseness.....		I	←	←

Direction switch

Operating condition, damage.....		I	←	←
----------------------------------	--	---	---	---

Controller

Operating condition.....		I	←	←
Interior contamination and damage.....		C	←	←
Motor input voltage.....				M

Fuses

Looseness.....		I	←	←
----------------	--	---	---	---



REPLACEMENT CYCLE (Based on total operating hours or months, whichever comes first)	EVERY	6 WEEKS	3	6	12	months
	EVERY	250	500	1000	2000	hours
Wiring (including charging cord)						
Harness deterioration, damage and looseness of clamp	I*	I	←	←		
Looseness of the connections, taping condition	I*	I	←	←		
Connecting condition and damage of the battery connector	I*	I	←	←		
POWER TRANSMISSION SYSTEM						
Drive unit						
Oil leakage		I	←	←		
Oil level		I	←	←		
Bolt or nut looseness					T	
DRIVE SYSTEM						
Wheels						
Tire pressure (OPT)		M	←	←		
Tire cuts, damage or uneven treads		I	←	←		
Hub nut looseness		T	←	←		
Tread depth	M*	M	←	←		
Metal chips, pebbles or other foreign matter trapped in tire treads	I*	I	←	←		
Rim side ring and disc wheel damage	I*	I	←	←		
Front wheel bearing abnormal noise and looseness	I*	I	←	←		
Rear wheel bearing abnormal noise and looseness	I*	I	←	←		
Front axle						
Deformation and damage					I	
Rear axle						
Deformation and damage					I	
Abnormal noise looseness of rear axle bearing					I	
Loosens of axle beam in vehicle longitudinal direction	M*				M	
STEERING SYSTEM						
Steering wheel						
Play, looseness and loosening	I*	I	←	←		
Operating condition	I*	I	←	←		
Steering valve						
Oil leakage	I*	I	←	←		
Mounting looseness	T*	T	←	←		
Steering system						
Steering angle to right and left					I	
Power steering						
Oil leakage and oil level		I	←	←		
Looseness in mounting parts		I	←	←		
Power steering hose damage					I	

REPLACEMENT CYCLE (Based on total operating hours or months, whichever comes first)	EVERY	6 WEEKS	3	6	12	months
	EVERY	250	500	1000	2000	hours
BRAKING SYSTEM						
Brake pedal						
Braking performance			I	←	←	
Reserve			M	←	←	
Parking brake						
Pull margin and operating force			I	←	←	
Braking performance			I	←	←	
Rods and cables						
Loosening, looseness or damage	I*	I	←	←		
Operating condition	I*	I	←	←		
Wet disc brake						
Oil leak	I*	I	←	←		
Oil level	I*				I	
Wear of sliding portion and pad					*2	
Disc wear and damage					*2	
Pedal stroke	M*				M	
Operating condition					I	
Return spring fatigue					*2	
MATERIAL HANDLING SYSTEM						
Fork						
Damage and wear of fork and stopper pin			I	←	←	
Misalignment between left and right fork fingers			I	←	←	
Cracks at forks root and welded portion					I*1	
Mast and lift bracket						
Deformation, damage and cracks in welded portion			I	←	←	
Wear, damage and rotating condition of roller			I	←	←	
Mast and lift bracket looseness			I	←	←	
Wear and damage of mast support bushing			I	←	←	
Wear and damage of roller pin			I	←	←	
Wear and damage of mast pads			I	←	←	
Chain and chain wheel						
Tension deformation, damage and slackness of chain	I*	I	←	←		
Chain lubrication			I	←	←	
Abnormality of chain anchor bolt and nut			I	←	←	
Wear, damage and revolution of chain wheel			I	←	←	
Attachment (OPT)						
Abnormalities and mounting condition			I	←	←	



REPLACEMENT CYCLE (Based on total operating hours or months, whichever comes first)	EVERY	6 WEEKS	3	6	12	months
	EVERY	250	500	1000	2000	hours
HYDRAULIC SYSTEM						
Cylinder						
Cylinder mounting looseness, damage			T	←	←	
Looseness, deformation and damage of rod and rod end.....			I	←	←	
Cylinder operation			I	←	←	
Natural drop, natural forward tilt			M	←	←	
Oil leakage and damage			I	←	←	
Pin and cylinder shaft support wear and damage.....			I	←	←	
Lifting speed			M	←	←	
Uneven movement			I	←	←	
Hydraulic pump						
Oil leakage and abnormal noise			I	←	←	
Hydraulic oil tank						
Oil level, contamination.....			I	←	←	
Tank and oil strainer.....				C	←	
Oil leakage			I	←	←	
Hydraulic filter						
Filter clogging.....					C	
Control lever						
Operation.....			I	←	←	
Oil control valve						
Oil leakage			I	←	←	
Relief pressure measurement					M	
Safety valve function			I	←	←	
Hydraulic hose and piping						
Oil leakage			I	←	←	
Deformation and damage.....			I	←	←	
Linkage looseness			T	←	←	
SAFETY DEVICES, ETC.						
Head guard						
Welded portion cracks.....			I	←	←	
Deterioration, damage.....			I	←	←	

REPLACEMENT CYCLE (Based on total operating hours or months, whichever comes first)	EVERY	6 WEEKS	3	6	12	months
	EVERY	250	500	1000	2000	hours
Backrest						
Looseness in mounting parts			T	←	←	
Deterioration, cracks and damage			I	←	←	
Lighting system (OPT)						
Operation, mounting condition			I	←	←	
Horn						
Operation, mounting condition			I	←	←	
Turn signals (OPT)						
Operation, mounting condition			I	←	←	
Instruments						
Operation			I	←	←	
Backup buzzer (OPT)						
Operation, mounting condition.....			I	←	←	
SAS.						
Operation			I	←	←	
Looseness and/or damage at sensor fittings			I	←	←	
Damage to, deformation of and/or oil leakage at functional parts and loose mounting.....			I	←	←	
Looseness at and/or damage to wire harnesses			I	←	←	
Performance of lock cylinder and/or accumulator (4 wheels only).....					I	
Load sensor rust or corrosion					I	
OPS						
Function		I*	I	←	←	
Seat						
Mounting looseness, damage.....			I	←	←	
Seat belt damage and operation			I	←	←	
Deadman seat operation.....			I	←	←	
Seat switch operating condition.....		I*	I	←	←	
Body						
Frame, cross member, etc. damage, cracking.....					I	
Bolt and nut looseness					T	
Rear-view mirror (OPT)						
Dirt, damage			I	←	←	
Rear reflection			I	←	←	
Heater (OPT)						
Filter cleaning.....			I	←	←	
Other						
Lubrication status			L	←	←	

*: For new vehicles
*1: Fissure and crack detector
*2: Inspection every 21000 hours

Note:

In case of hard operating conditions, the service interval of 170 hours or 1 month may be recommendable.



SERVICE DATA

Adjustment value table

Item	Vehicle model	8FBET15	8FBE(K)T16	8FBE(K)T18	8FBET20	8FBMT15	8FBMT16	8FBMT18	8FBMT20
Steering wheel play	mm (in.)	20-50 (0.79-1.97)	←	←	←	←	←	←	←
Battery electrolyte specific gravity (20°C) (Reference)	Standard	1.280	←	←	←	←	←	←	←
	Limit	1.150	←	←	←	←	←	←	←
Oil control valve set pressure	Mpa (kg/cm ²) [psi]	Lift / Tilt 18.3 (187) [2654]	←	←	←	←	←	←	←
Parking brake operating force					150 N (3-4 notch)				
Brake pedal play					1-5mm				
Brake pedal floor clearance (floor mat)					99 +/- 2.5mm				
Hub nut tightening torque	N·m (kgf·m) [lbf·ft]	Front	117.6-196 (12-20) [87-145]	←	←	←	←	←	←
		Rear	117.6-196 (12-20) [87-145]	←	←	←	←	←	←
Sound pressure level (L _{pA}) in accordance with EN 12053 Uncertainty K=4 dB(A)	dB (A)	70.7	←	←	←	←	←	←	73.5

*Note

- The vibration values shown above are obtained from the measurements in accordance with EN 13059.
- The magnitude of hand arm vibration of lift trucks is 2.5m/s² or below as defined in EN 13059.
- The whole body vibration values shown above cannot be used for calculating 8 hour vibration exposure in 2002/44/EC (Vibration Directive).
If calculated according to the general forklift operation pattern, the result will be lower than 0.5 m/s².)
- The sound pressure values shown above can be used as the sound level at operators' ears. (Values are in accordance with EN 12053 measurement methods.)



Fuse capacity table

Fuse	All models
F1 (drive)	400A
F4 (lamp)	10A
F5 (control circuit)	10A
F6 (control circuit)	10A
F7 (fan and solenoid)	10A

Lubricant capacity and type table

Applicable place	Capacity	Type
Drive unit, differential	0.43 l (0.114 US gal)	• ATF type T-4
Wet disc brake	0.21 l (0.055 US gal)	• ATF type T-4
Hydraulic oil	see "Hydraulic oil level by lifting height" below	• standard vehicle: Agip Arnica 32 or equivalent • cold storage vehicle: Agip Arnica A 15 or equivalent
Chassis and mast Grease fitting	Proper amount	• MP grease • Molybdenum disulfide grease • Esso beacon 32S
Battery	Proper amount	• Distilled water

Hydraulic oil level by lifting height

Mast	Height	volume of oil (l) (without attachment)
V	≤4000	14
	4001-5000	16
	5001-5500	17
FSW	≤4000	15
	4001-5000	17
	5001-6000	19
	6001-7000	19
	7001-7500	20
FV	≤4000	13

Note:

Add 0,7 l for trucks equipped with Side Shifter (OPT)

BATTERY CASE & MINIMUM WEIGHT REQUIRED

When purchasing the battery locally, adjust its weight to satisfy the minimum required weight by referring to the table below.

	Vehicle model	Case dimensions mm			Minimum required battery weight (With case) kg
		Front to rear length X	Width Y	Height Z	
3W	8FBET15	522	830	627	672
	8FBET16-18	630	↑	↑	813
	8FBET16-20	738	↑	↑	962
4W	8FBMT15	522	↑	↑	672
	8FBMT16-20	738	↑	↑	962

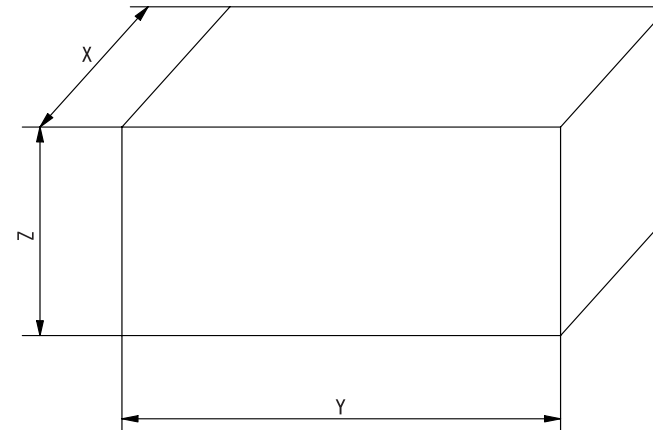



WHEELS & TIRES (3W)

Vehicle model	Type		Tire size	Wheel size	Tire pressure kPa	Remarks	
8FBET15 8FBET16 8FBET16	Front	Pneumatic Shaped Cushion	J-LUG	18×7-8	4.33R-8	-	Standard
		Pneumatic	↑	18×7-8-16PR	4.33R-8	1000	Option
		Non-Marking	↑	18×7-8	4.33R-8	-	Option
8FBET18 8FBET18	Front	Pneumatic Shaped Cushion	↑	18×7-8	4.33R-8	-	Standard
		Pneumatic	↑	200/50-10	6.50F-10	-	Option
		Non-Marking	↑	-	-	-	not applicable
8FBET20	Front	Pneumatic Shaped Cushion	↑	18×7-8	4.33R-8	-	Option
		Pneumatic	↑	200/50-10	6.50F-10	-	Option
		Non-Marking	↑	200/50-10	6.50F-10	-	Option
8FBET15 8FBET16 8FBET16	Rear	Pneumatic Shaped Cushion	↑	15×4 1/2-8	3.00D-8	-	Standard
		Pneumatic Shaped Cushion	↑	140/55-9	4.00E-9	-	Option
		Pneumatic	↑	15×4 1/2-8-12PR	3.00D-8	1000	Option
		Non-Marking	↑	15×4 1/2-8	3.00D-8	-	Option
8FBET18 8FBET18 8FBET20	Rear	Pneumatic Shaped Cushion	↑	140/55-9	4.00E-9	-	Standard
		Pneumatic	↑	-	-	-	not applicable
		Non-Marking	↑	140/55-9	4.00E-9	-	Option

WHEELS & TIRES (4W)

Vehicle model	Type		Tire size	Wheel size	Tire pressure kPa	Remarks	
8FBMT15 8FBMT16	Front	Pneumatic Shaped Cushion	J-LUG	18×7-8	4.33R-8	-	Standard
		Pneumatic	↑	18×7-8-16PR	4.33R-8	1000	Option
		Non-Marking	↑	18×7-8	4.33R-8	-	Option
8FBMT18	Front	Pneumatic Shaped Cushion	↑	18×7-8	4.33R-8	-	Standard
		Pneumatic	↑	200/50-10	6.50F-10	-	Option
		Non-Marking	↑	-	-	-	not applicable
8FBMT20	Front	Pneumatic Shaped Cushion	↑	18×7-8	4.33R-8	-	Option
		Pneumatic	↑	200/50-10	6.50F-10	-	Option
		Non-Marking	↑	200/50-10	6.50F-10	-	Option
8FBMT15 8FBMT16 8FBMT18	Rear	Pneumatic Shaped Cushion	↑	16×6-8	4.33R-8	-	Standard
		Pneumatic	↑	16×6-8-10PR	4.33R-8	800	Option
		Non-Marking	↑	16×6-8	4.33R-8	-	Option
8FBMT20	Rear	Pneumatic Shaped Cushion	↑	16×6-8	4.33R-8	-	Standard
		Pneumatic	↑	-	-	-	not applicable
		Non-Marking	↑	16×6-8	4.33R-8	-	Option

En

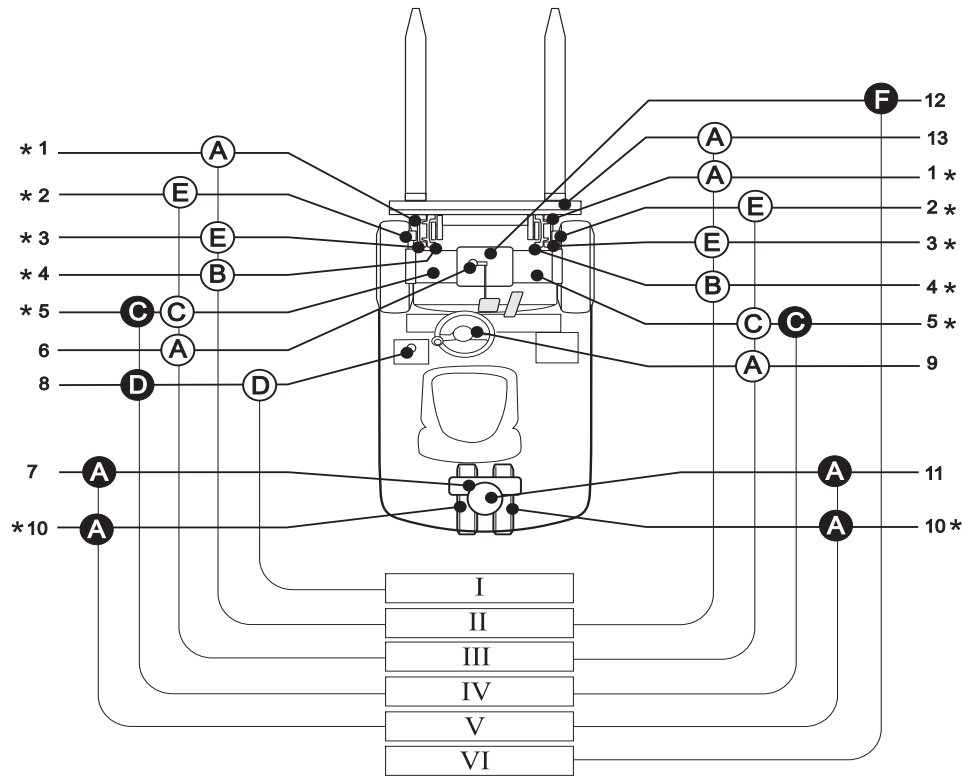

LUBRICATION CHART (3W)

1. Mast strip
2. Tilt cylinder front pin
3. Mast support bushing
4. Lift chain
5. Drive unit
6. Brake pedal link
7. Steering rack & pinion gear
8. Oil tank
9. Tilt steering lock mechanism
10. Rear wheel bearing
11. Rear axle bearing
12. Wet disc brake
13. Side Shifter (OPT)

- I) Inspect every 8 hours (daily)
 II) Inspect every 40 hours (weekly)
 III) Inspect every 250 hours (6-weeks)
 IV) Inspect every 1000 hours (semi-annually)
 V) Inspect every 2000 hours (annually)
 VI) Inspect every 3000 hours (1.5 years)

- Inspection and supply
 ● Replacement
 * Located both right and left

- A) MP Grease
 B) Motor oil
 C) Gear oil (ATF type T-IV)
 D) Hydraulic oil (ISO VG32)
 E) Molybdenum disulfide grease
 F) ATF type T-IV

Note:

In case of the hard operating condition, the service interval of 170 hours or 1 month may be recommendable.

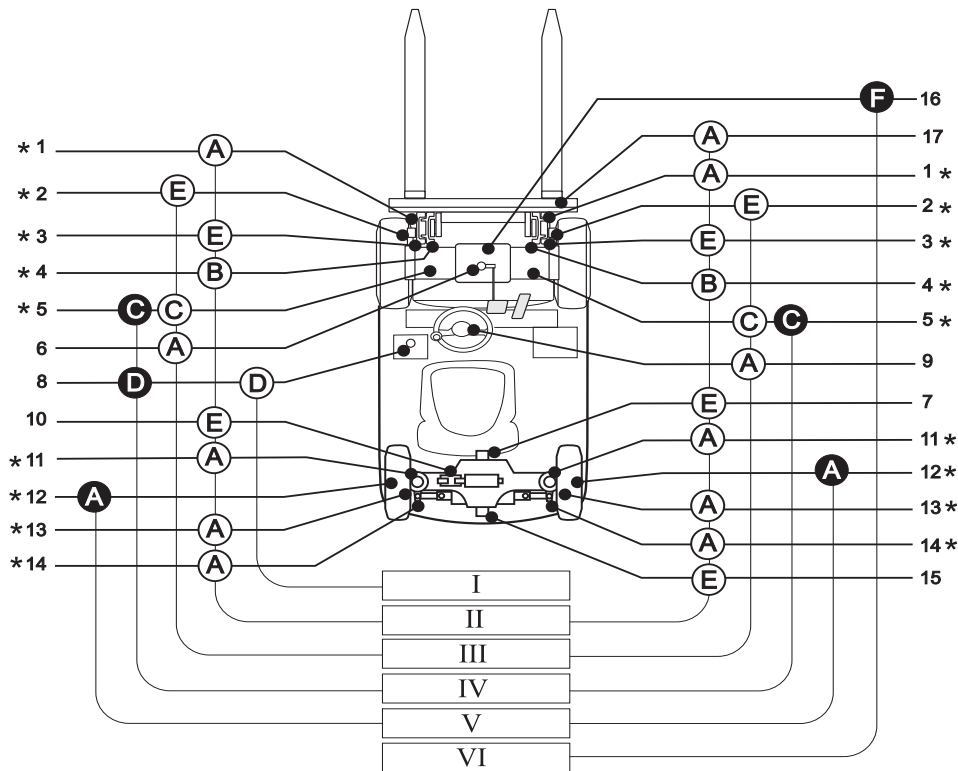

LUBRICATION CHART (4W)

1. Mast strip
2. Tilt cylinder front pin
3. Mast support bushing
4. Lift chain
5. Drive unit
6. Brake pedal link
7. Rear axle beam front pin
8. Oil tank
9. Tilt steering lock mechanism
10. Swing lock cylinder crank and rod pin
11. Steering knuckle king pin
12. Rear wheel bearing
13. Tie rod end pin
14. Rear axle cylinder end pin
15. Rear axle beam rear pin
16. Wet disc brake
17. Side Shifter (OPT)

- I) Inspect every 8 hours (daily)
- II) Inspect every 40 hours (weekly)
- III) Inspect every 250 hours (6-weeks)
- IV) Inspect every 1000 hours (semi-annually)
- V) Inspect every 2000 hours (annually)
- VI) Inspect every 3000 hours (1.5 years)

- Inspection and supply
- Replacement
- * Located both right and left

- A) MP Grease
- B) Motor oil
- C) Gear oil (ATF type T-IV)
- D) Hydraulic oil (ISO VG32)
- E) Molybdenum disulfide grease
- F) ATF type T-IV

Note:

In case of the hard operating condition, the service interval of 170 hours or 1 month may be recommendable.



VEHICLE DIMENSIONS

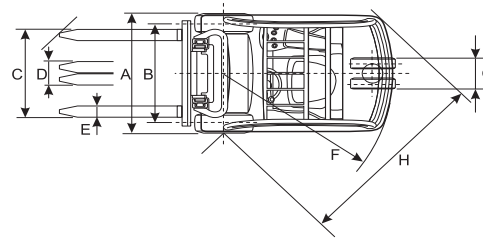
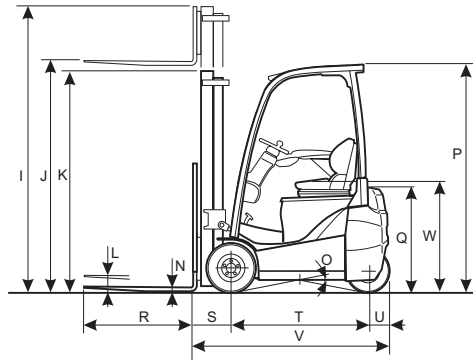

3 WHEELS						
	8FBET15	8FBEKT16	8FBET16	8FBEKT18	8FBET18	8FBET20
A	1050mm	←	←	←	←	1122mm
B	894mm	←	←	←	←	914mm
C	920mm	←	←	←	←	←
D	200mm	←	←	←	←	240mm
E	100mm	←	←	←	←	120mm
F	1434mm	1542mm	1650mm	1542mm	1650mm	1650mm
G	175.4mm	175.4mm	175.4mm	181mm	181mm	181mm
H	1434mm	1542mm	1650mm	1542mm	1650mm	1650mm
I	3845mm	←	←	←	←	←
J	3300mm	←	←	←	←	←
K	2150mm	←	←	←	←	←
L	120mm	←	←	←	←	←
N	35mm	←	←	←	←	←
O	30%	27%	25%	28%←	26%←	27%
P	2055mm	←	←	←	←	←
Q	924mm	←	←	1017mm	929mm	1017mm
R	1000mm	←	←	←	←	←
S	348mm	←	←	355mm	←	←
T	1264mm	1372mm	1480mm	1372mm	1480mm	←
U	170.5mm	177.5mm	←	170mm	←	←
V	1782mm	1890mm	1998mm	1897mm	2005mm	←
W	944mm	←	←	←	←	952mm

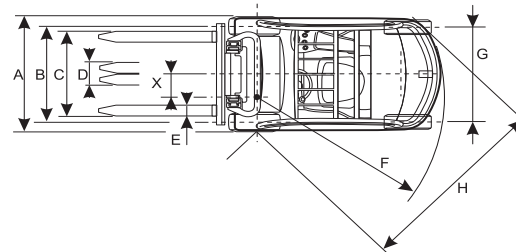
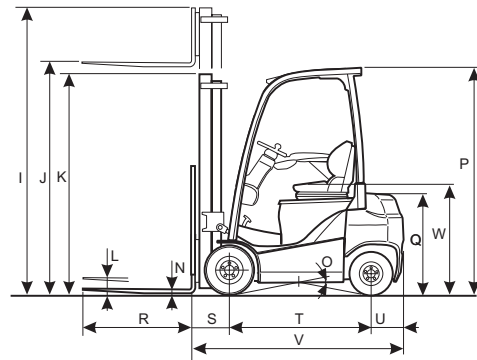

4 WHEELS				
	8FBMT15	8FBMT16	8FBMT18	8FBMT20
A	1050mm	←	←	1122.2mm
B	894mm	←	←	914mm
C	920mm	←	←	←
D	200mm	←	←	240mm
E	100mm	←	←	120mm
F	1639mm	1845mm	←	←
G	880mm	←	←	←
H	1639mm	1845mm	←	←
I	3845mm	←	←	←
J	3300mm	←	←	←
K	2150mm	←	←	←
L	120mm	←	←	←
N	35mm	←	←	←
O	33%	28%	28%	29%
P	2055mm	←	←	←
Q	946mm	←	←	←
R	1000mm	←	←	←
S	348mm	←	355mm	←
T	1264mm	1530mm	←	←
U	307.5mm	←	300mm	←
V	1962mm	2178mm	2185mm	←
W	944mm	←	←	952mm
X	205mm	186mm	←	←



FRAME SERIAL NUMBER

Frame serial number location

The frame serial number is stamped on the front cross plate. Please refer to the frame serial number when making inquiries about your vehicle.

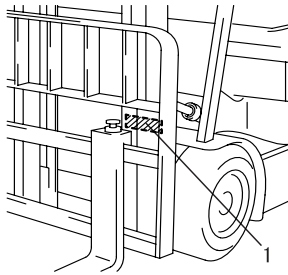

(1) Frame serial number location

TOYOTA FORKLIFT TRUCK			
M O D E L	(1)	FRONT TREAD	(6)
CODE NO. OF SPECIAL MODEL	(2)	TIRE SIZE FR	(7)
MODEL OF ATTACHMENT	(3)	TIRE PRESS. FR	(8)
FRAME NO.	(4)	TIRE SIZE RR	(7)
TRUCK WEIGHT WITHOUT BATTERY	(5)	TIRE PRESS. RR	(8)
MAX. LIFTING HEIGHT "A"	(5)	PROD. YEAR	(9)
BATTERY WEIGHT MIN./MAX.	(11)	VOLTAGE	(10) V
RATED CAPACITY	(12)	ACTUAL CAPACITY WITH VERTICAL LIFT	(13)
ACTUAL CAPACITY	(13)	ACTUAL CAPACITY WITH VERTICAL LIFT EQUIPPED AS SHOWN	(13)
LOAD CENTER "B"	(14)	LOAD CENTER "B"	(14)

TOYOTA INDUSTRIAL EQUIPMENT S. A.
ANGENIS, FRANCE ENGLISH 57742-F1060-71

HOW TO READ THE NAME PLATE

For certain areas, instead of on the load capacity chart, the vehicle's allowable load is engraved on the name plate. Check the load center and capacity before starting operation.

- (1) Vehicle model
- (2) Specialty model, Attachment model
- (3) Frame No.
- (4) Vehicle weight (excluding battery)
- (5) Maximum lifting height
- (6) Front tread
- (7) Tire size
- (8) Tire pressure
- (9) The year of manufacture
- (10) Battery voltage
- (11) Battery unit weight (min. and max.)
- (12) Maximum load
- (13) Actual load
- (14) Load center

En



MAST SPECIFICATIONS AND RATED CAPACITIES

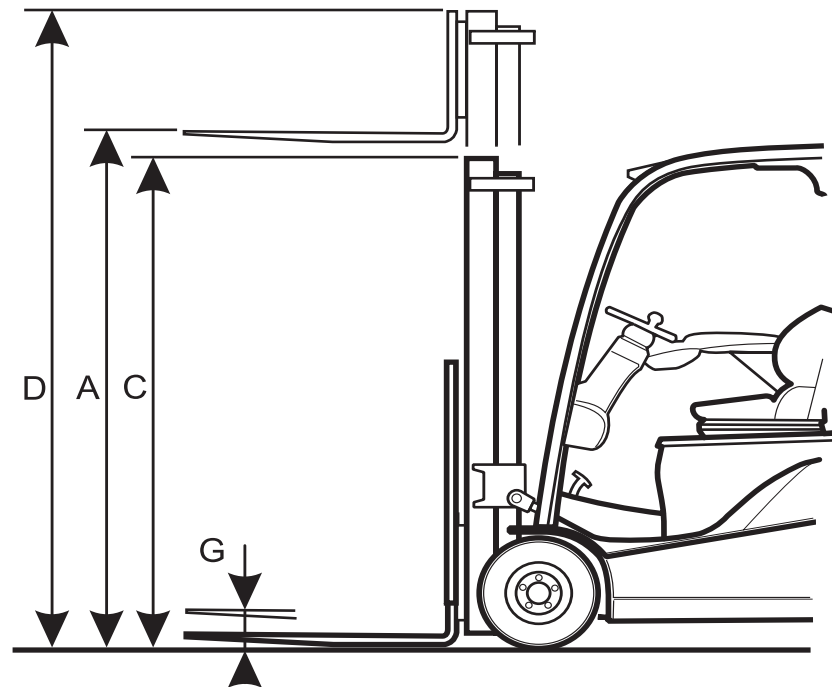

	A Maximum lifting height	B Overall Height			G Free Lift (Top of Forks)		J Standard tread			O Wide Tread		
		C Lowered	D Extended		H Without Load Backrest	I With Standard Load Backrest	K Tilt Range		N Load capacity	P Tilt Range		S Load capacity
			E Without Load Backrest	F With Standard Load Backrest			L Forward	M Backward		Q Forward	R Backward	
									500 mm Load center			500 mm Load center
mm	mm	mm	mm	mm	mm	deg	deg	kg	deg	deg	kg	

V
Wide Visible Mast

FW
Wide Visible Full-Free Lift Two-Stage Mast

FSW
Wide Visible Full-Free Lift Three-Stage Mast

deg
Deg



8FBET15

	A	B		G		J			O			
		C	D		H	I	K		N 500 mm LC	P		S 500 mm LC
			E	F			L	M		Q	R	
	mm	mm	mm	mm	mm	mm	deg	deg	kg	deg	deg	kg
V	3000	2000	3545	4260	120	120	5	7	1500	5	7	1500
	3300	2150	3845	4560	120	120	5	7	1500	5	7	1500
	3500	2250	4045	4760	120	120	7	5	1500	5	7	1500
	3700	2350	4245	4960	120	120	5	7	1500	5	7	1500
	4000	2550	4545	5260	120	120	5	7	1500	5	7	1450
	4200	2650	4745	5460	120	120	5	7	1500	5	7	1400
	4500	2800	5045	5760	120	120	5	7	1500	5	7	1350
	4700	2900	5245	5960	120	120	5	7	1470	5	7	1300
FW	5000	3100	5545	6260	120	120	5	7	1450	5	7	1250
	3000	2000	3555	4260	1485	780	5	7	1500	5	7	1500
	3300	2150	3855	4560	1635	930	5	7	1500	5	7	1500
	3500	2250	4055	4760	1735	1030	5	7	1500	5	7	1500
FSW	3700	2350	4255	4960	1835	1130	5	7	1500	5	7	1500
	4300	1980	4845	5560	1475	760	5	7	1450	5	7	1400
	4500	2050	5045	5760	1545	830	5	7	1430	5	7	1370
	4700	2150	5245	5960	1645	930	5	7	1420	5	7	1350
	5000	2250	5545	6260	1745	1030	5	7	1380	5	7	1200
	5500	2450	6045	6760	1945	1230	5	7	1320	5	7	900
	6000	2600	6545	7260	2095	1380	5	5	1200	5	5	700
	6500	2800	7045	7760	2295	1580	5	5	900	5	5	550
	7000	3000	7545	8260	2495	1780	5	5	650	5	5	400
7500	3200	8045	8760	2695	1980	5	5	400	5	5	300	

Height of standard load backrest is 1220 mm.



8FBECT16 - 8FBET16

	A	B		G		J			O			
		C	D		H	I	K		N 500 mm LC	P		S 500 mm LC
	E		F	L			M	Q		R		
	mm	mm	mm	mm	mm	mm	deg	deg	kg	deg	deg	kg
V	3000	2000	3545	4260	120	120	5	7	1600	5	7	1600
	3300	2150	3845	4560	120	120	5	7	1600	5	7	1600
	3500	2250	4045	4760	120	120	7	5	1600	5	7	1600
	3700	2350	4245	4960	120	120	5	7	1600	5	7	1600
	4000	2550	4545	5260	120	120	5	7	1600	5	7	1550
	4200	2650	4745	5460	120	120	5	7	1600	5	7	1520
	4500	2800	5045	5760	120	120	5	7	1600	5	7	1500
	4700	2900	5245	5960	120	120	5	7	1570	5	7	1450
FW	3000	2000	3555	4260	1485	780	5	7	1600	5	7	1500
	3300	2150	3855	4560	1635	930	5	7	1600	5	7	1500
	3500	2250	4055	4760	1735	1030	5	7	1600	5	7	1500
	3700	2350	4255	4960	1835	1130	5	7	1600	5	7	1500
FSW	4300	1980	4845	5560	1475	760	5	7	1550	5	7	1450
	4500	2050	5045	5760	1545	830	5	7	1500	5	7	1420
	4700	2150	5245	5960	1645	930	5	7	1450	5	7	1400
	5000	2250	5545	6260	1745	1030	5	7	1400	5	7	1300
	5500	2450	6045	6760	1945	1230	5	7	1350	5	7	950
	6000	2600	6545	7260	2095	1380	5	5	1300	5	5	750
	6500	2800	7045	7760	2295	1580	5	5	1000	5	5	600
	7000	3000	7545	8260	2495	1780	5	5	750	5	5	450
7500	3200	8045	8760	2695	1980	5	5	500	5	5	350	

Height of standard load backrest is 1220 mm.



8FBET18 - 8FBET18

	A	B			G		J		
		C	D		H	I	K		N
			E	F			L	M	500 mm LC
mm	mm	mm	mm	mm	mm	deg	deg	kg	
V	3000	2000	3545	4260	120	120	5	7	1800
	3300	2150	3845	4560	120	120	5	7	1800
	3500	2250	4045	4760	120	120	7	5	1800
	3700	2350	4245	4960	120	120	5	7	1800
	4000	2550	4545	5260	120	120	5	7	1800
	4200	2650	4745	5460	120	120	5	7	1750
	4500	2800	5045	5760	120	120	5	7	1700
	4700	2900	5245	5960	120	120	5	7	1650
FW	5000	3100	5545	6260	120	120	5	7	1600
	3000	2000	3555	4260	1485	780	5	7	1800
	3300	2150	3855	4560	1635	930	5	7	1800
	3500	2250	4055	4760	1735	1030	5	7	1800
FSW	3700	2350	4255	4960	1835	1130	5	7	1800
	4300	1980	4845	5560	1475	760	5	7	1650
	4500	2050	5045	5760	1545	830	5	7	1620
	4700	2150	5245	5960	1645	930	5	7	1600
	5000	2250	5545	6260	1745	1030	5	7	1550
	5500	2450	6045	6760	1945	1230	5	7	1450
	6000	2600	6545	7260	2095	1380	5	5	1350
	6500	2800	7045	7760	2295	1580	5	5	1050
	7000	3000	7545	8260	2495	1780	5	5	800
7500	3200	8045	8760	2695	1980	5	5	550	

Height of standard load backrest is 1220 mm.



8FBET20

	A	B			G		J		
		C	D		H	I	K		N
	E		F	L			M	500 mm LC	
	mm	mm	mm	mm	mm	mm	deg	deg	kg
V	3000	2000	3545	4260	120	120	5	7	2000
	3300	2150	3845	4560	120	120	5	7	2000
	3500	2250	4045	4760	120	120	7	5	2000
	3700	2350	4245	4960	120	120	5	7	2000
	4000	2550	4545	5260	120	120	5	7	2000
	4200	2650	4745	5460	120	120	5	7	2000
	4500	2800	5045	5760	120	120	5	7	2000
	4700	2900	5245	5960	120	120	5	7	1920
FW	5000	3100	5545	6260	120	120	5	7	1850
	3000	2000	3555	4260	1485	780	5	7	2000
	3300	2150	3855	4560	1635	930	5	7	2000
	3500	2250	4055	4760	1735	1030	5	7	2000
FSW	3700	2350	4255	4960	1835	1130	5	7	2000
	4300	1980	4845	5560	1475	760	5	7	1800
	4500	2050	5045	5760	1545	830	5	7	1780
	4700	2150	5245	5960	1645	930	5	7	1750
	5000	2250	5545	6260	1745	1030	5	7	1700
	5500	2450	6045	6760	1945	1230	5	7	1650
	6000	2600	6545	7260	2095	1380	5	5	1550
	6500	2800	7045	7760	2295	1580	5	5	1250
	7000	3000	7545	8260	2495	1780	5	5	1000
7500	3200	8045	8760	2695	1980	5	5	750	

Height of standard load backrest is 1220 mm.



8FBMT15

	A	B		G		J			O			
		C	D		H	I	K		N 500 mm LC	P		S 500 mm LC
			E	F			L	M		Q	R	
	mm	mm	mm	mm	mm	mm	deg	deg	kg	deg	deg	kg
V	3000	2000	3545	4260	120	120	5	7	1500	5	7	1500
	3300	2150	3845	4560	120	120	5	7	1500	5	7	1500
	3500	2250	4045	4760	120	120	7	5	1500	5	7	1500
	3700	2350	4245	4960	120	120	5	7	1500	5	7	1500
	4000	2550	4545	5260	120	120	5	7	1500	5	7	1500
	4200	2650	4745	5460	120	120	5	7	1480	5	7	1480
	4500	2800	5045	5760	120	120	5	7	1450	5	7	1450
	4700	2900	5245	5960	120	120	5	7	1450	5	7	1400
FW	5000	3100	5545	6260	120	120	5	7	1400	5	7	1350
	3000	2000	3555	4260	1485	780	5	7	1350	5	7	1500
	3300	2150	3855	4560	1635	930	5	7	1500	5	7	1500
	3500	2250	4055	4760	1735	1030	5	7	1500	5	7	1500
FSW	3700	2350	4255	4960	1835	1130	5	7	1500	5	7	1500
	4300	1980	4845	5560	1475	760	5	7	1450	5	7	1400
	4500	2050	5045	5760	1545	830	5	7	1450	5	7	1380
	4700	2150	5245	5960	1645	930	5	7	1400	5	7	1350
	5000	2250	5545	6260	1745	1030	5	7	1400	5	7	1200
	5500	2450	6045	6760	1945	1230	5	7	1250	5	7	1100
	6000	2600	6545	7260	2095	1380	5	5	1100	5	5	900
	6500	2800	7045	7760	2295	1580	5	5	900	5	5	800
	7000	3000	7545	8260	2495	1780	5	5	850	5	5	700
7500	3200	8045	8760	2695	1980	5	5	700	5	5	600	

Height of standard load backrest is 1220 mm.



8FBMT16

	A	B		G		J			O			
		C	D		H	I	K		N 500 mm LC	P		S 500 mm LC
			E	F			L	M		Q	R	
	mm	mm	mm	mm	mm	mm	deg	deg	kg	deg	deg	kg
V	3000	2000	3545	4260	120	120	5	7	1600	5	7	1600
	3300	2150	3845	4560	120	120	5	7	1600	5	7	1600
	3500	2250	4045	4760	120	120	7	5	1600	5	7	1600
	3700	2350	4245	4960	120	120	5	7	1600	5	7	1600
	4000	2550	4545	5260	120	120	5	7	1600	5	7	1600
	4200	2650	4745	5460	120	120	5	7	1600	5	7	1600
	4500	2800	5045	5760	120	120	5	7	1550	5	7	1550
	4700	2900	5245	5960	120	120	5	7	1500	5	7	1500
FW	5000	3100	5545	6260	120	120	5	7	1450	5	7	1450
	3000	2000	3555	4260	1485	780	5	7	1600	5	7	1600
	3300	2150	3855	4560	1635	930	5	7	1600	5	7	1600
	3500	2250	4055	4760	1735	1030	5	7	1600	5	7	1600
FSW	3700	2350	4255	4960	1835	1130	5	7	1600	5	7	1600
	4300	1980	4845	5560	1475	760	5	7	1550	5	7	1500
	4500	2050	5045	5760	1545	830	5	7	1550	5	7	1450
	4700	2150	5245	5960	1645	930	5	7	1500	5	7	1450
	5000	2250	5545	6260	1745	1030	5	7	1450	5	7	1300
	5500	2450	6045	6760	1945	1230	5	7	1350	5	7	1200
	6000	2600	6545	7260	2095	1380	5	5	1200	5	5	1000
	6500	2800	7045	7760	2295	1580	5	5	1050	5	5	900
	7000	3000	7545	8260	2495	1780	5	5	900	5	5	800
7500	3200	8045	8760	2695	1980	5	5	750	5	5	700	

Height of standard load backrest is 1220 mm.



8FBMT18

	A	B		G		J			O			
		C	D		H	I	K		N 500 mm LC	P		S 500 mm LC
			E	F			L	M		Q	R	
	mm	mm	mm	mm	mm	mm	deg	deg	kg	deg	deg	kg
V	3000	2000	3545	4260	120	120	5	7	1800	5	7	1800
	3300	2150	3845	4560	120	120	5	7	1800	5	7	1800
	3500	2250	4045	4760	120	120	7	5	1800	5	7	1800
	3700	2350	4245	4960	120	120	5	7	1800	5	7	1800
	4000	2550	4545	5260	120	120	5	7	1800	5	7	1800
	4200	2650	4745	5460	120	120	5	7	1800	5	7	1800
	4500	2800	5045	5760	120	120	5	7	1750	5	7	1750
	4700	2900	5245	5960	120	120	5	7	1700	5	7	1700
FW	3000	2000	3555	4260	1485	780	5	7	1800	5	7	1800
	3300	2150	3855	4560	1635	930	5	7	1800	5	7	1800
	3500	2250	4055	4760	1735	1030	5	7	1800	5	7	1800
	3700	2350	4255	4960	1835	1130	5	7	1800	5	7	1800
FSW	4300	1980	4845	5560	1475	760	5	7	1700	5	7	1600
	4500	2050	5045	5760	1545	830	5	7	1700	5	7	1580
	4700	2150	5245	5960	1645	930	5	7	1600	5	7	1550
	5000	2250	5545	6260	1745	1030	5	7	1600	5	7	1350
	5500	2450	6045	6760	1945	1230	5	7	1450	5	7	1250
	6000	2600	6545	7260	2095	1380	5	5	1250	5	5	1050
	6500	2800	7045	7760	2295	1580	5	5	1100	5	5	950
	7000	3000	7545	8260	2495	1780	5	5	950	5	5	850
7500	3200	8045	8760	2695	1980	5	5	800	5	5	750	

Height of standard load backrest is 1220 mm.

En



8FBMT20

	A	B			G		J		
		C	D		H	I	K		N
			E	F			L	M	500 mm LC
mm	mm	mm	mm	mm	mm	deg	deg	kg	
V	3000	2000	3545	4260	120	120	5	7	2000
	3300	2150	3845	4560	120	120	5	7	2000
	3500	2250	4045	4760	120	120	7	5	2000
	3700	2350	4245	4960	120	120	5	7	2000
	4000	2550	4545	5260	120	120	5	7	2000
	4200	2650	4745	5460	120	120	5	7	2000
	4500	2800	5045	5760	120	120	5	7	1900
	4700	2900	5245	5960	120	120	5	7	1800
FW	5000	3100	5545	6260	120	120	5	7	1750
	3000	2000	3555	4260	1485	780	5	7	2000
	3300	2150	3855	4560	1635	930	5	7	2000
	3500	2250	4055	4760	1735	1030	5	7	2000
FSW	3700	2350	4255	4960	1835	1130	5	7	2000
	4300	1980	4845	5560	1475	760	5	7	1850
	4500	2050	5045	5760	1545	830	5	7	1850
	4700	2150	5245	5960	1645	930	5	7	1800
	5000	2250	5545	6260	1745	1030	5	7	1700
	5500	2450	6045	6760	1945	1230	5	7	1500
	6000	2600	6545	7260	2095	1380	5	5	1300
	6500	2800	7045	7760	2295	1580	5	5	1150
	7000	3000	7545	8260	2495	1780	5	5	1000
7500	3200	8045	8760	2695	1980	5	5	850	

Height of standard load backrest is 1220 mm.

